

BUILD—Home movies time-compression machine

60c ■ OCT. 1967

# Radio-Electronics

TELEVISION • SERVICING • HIGH FIDELITY

HUGO GERNSBACK, Editor-in-chief

A  
GERNSBACK  
PUBLICATION

**Hi-Fi  
1968**

Cartridges  
Speakers  
Components  
Systems  
Tape Recorders

## SHOP PROJECTS

FET Voltmeter

Transistor &  
Diode Tester

## REPAIR

CB Talk  
Trouble

Radio &  
TV Tough Dogs

**Trackability Tests**

(See page 32)



A0580 491168P05809LT08K  
T POULIN  
5809 LONDON RD  
DULUTH, GA 30096  
NW 55804

**PROTECTS AGAINST** • Bent Pointers • Burned-Out Resistors  
 • Damaged Pivots • Overheated Springs • Burned-Out Meter  
 • Changes in Accuracy Due to Overheating



**Model 630-PLK**

# BURNOUT PROOF V-O-M

**\$89.00**  
Suggested  
U.S.A. User Net

## USES UNLIMITED

School Classrooms • Field Engineers • Application Engineers  
 • Electrical, Radio, TV, and Appliance Servicemen • Electrical  
 Contractors • Factory Maintenance Men • Industrial Elec-  
 tronic Maintenance Technicians • Home Owners, Hobbyists

## FACTS MAKE FEATURES:

- 1** Comprehensive overload protection.
- 2** One selector switch minimizes chance of incorrect settings
- 3** Polarity reversing switch

Additional protection is provided by Model 630-PLK's new transistorized relay circuit. Transistorized overload sensing device does not load circuit under test, eliminating the possibility of damaging circuit components. A special meter shorting feature on "off" position offers high damping when moving tester. The exclusive patented Bar Ring Movement provides self-shielding and is not affected by stray magnetic fields. Wider spread scales, and unbreakable clear plastic window assure maximum readability. Diode network across meter protects against instantaneous transient voltage.

**TRIPLET ELECTRICAL INSTRUMENT COMPANY, BLUFFTON, OHIO**

## RANGES

DC Volts:	0-2.5-10-50-250-1,000-5,000 at 20,000 ohms/volt. 0-0.25 at 100 microamperes.
AC Volts:	0-3-10-50-250-1,000-5,000 at 5,000 ohms/volt.
Decibels:	-20 to +11, +21, +35, +49, +61, +75; "0" DB at 1 MW on 600 ohm line.
DC Microamperes:	0-100 at 250 Mv.
DC Milliamperes:	0-10-100-1,000 at 250 Mv.
DC Amperes:	0-10 at 250 Mv.
Ohms:	0-1,000-10,000 (4.4-44 at center scale),
Megohms:	0-1-100 (4,400-440,000 at center scale).

Output Volts (AC): 0-3-10-50-250-1,000 at 5,000 ohms/volt; jack with condenser in series with AC ranges.

## CARRYING CASE

Model 639-OS black leather carrying case, built-in stand, Flaps open to permit use of tester in the case. Suggested U.S.A. User Net. . . . . \$14.00

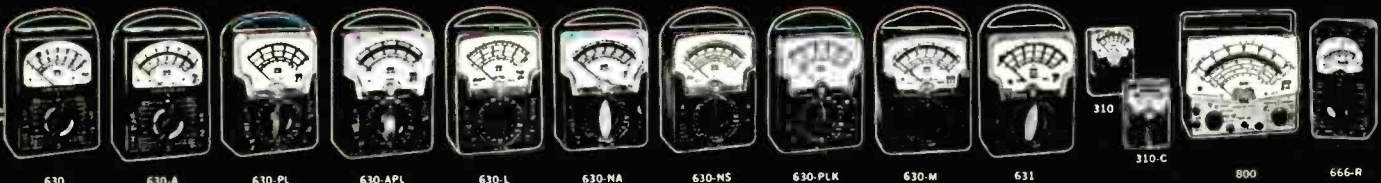

**THE WORLD'S MOST COMPLETE LINE OF V-O-M'S. AVAILABLE FROM YOUR TRIPLET DISTRIBUTOR'S STOCK.**

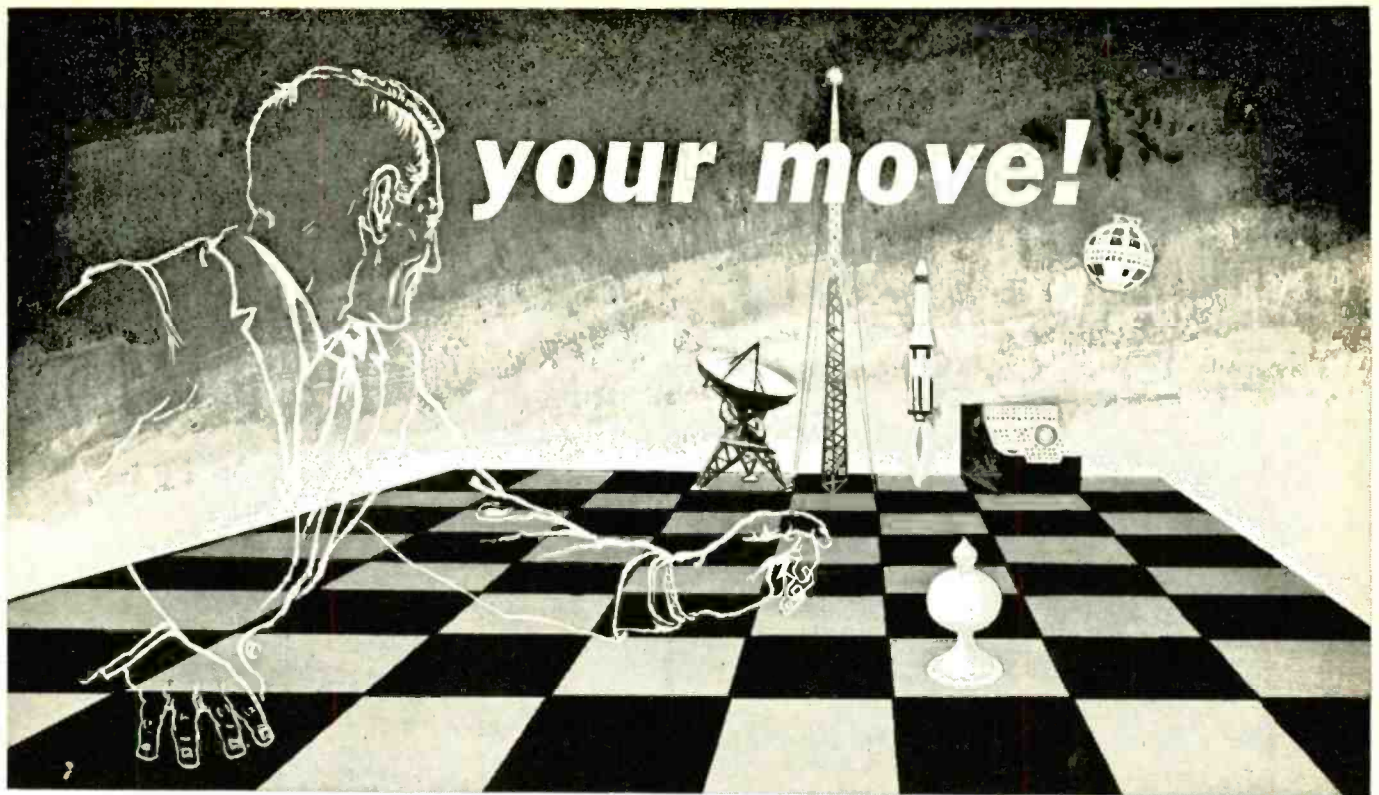

## The Move You Make Today Can Shape Your Future

As you know, this is the "electronics age." And electronics technology is changing so rapidly that the average technician's store of knowledge is highly obsolescent. He must get more education or get out of this field! He must understand *fundamental principles and concepts*. Only on the basis of such understanding can he easily adapt to the swift changes now occurring.

The technician who knows only the "how" of electronics is left behind again and again by new designs and techniques. But by comprehending the "why," he remains an *expert* — well paid and respected — in his field.

### Earn Your Associate Degree

Grantham strong-foundation training in electronics engineering technology leads to non-obsolescent skills — to skills which are based more on reasoning than on merely doing — and leads to the degree of *Associate in Science in Electronics Engineering* — the A.S.E.E. degree. As many as three semesters out of the five-semester degree program may be completed by correspondence, and the remainder of the curriculum in residence.

## Grantham School of Electronics

1505 N. Western Ave.      818 18th Street, N.W.  
Hollywood, Calif. 90027      or      Washington, D.C. 20006

Telephone:  
(213) 469-7878

Telephone:  
(202) 298-7460

### Get Your FCC License

An F.C.C. operator license is U.S. Government evidence of your knowledge in electronics. In the Grantham associate degree curriculum, you are more than prepared for your first class radio-telephone license and radar endorsement by the time you complete the first two semesters. However, if you are interested in a shorter course designed specifically to prepare you for F.C.C. license exams, ask for information about the Grantham F.C.C. License Course — an 88 lesson highly-effective correspondence course.

### Accreditation, and G.I. Bill Approval

Grantham School of Electronics is *accredited* by the Accrediting Commission of the National Home Study Council, and is *approved* for both correspondence and resident training under the G.I. Bill. Just mail the coupon (below), or write or telephone us for full information.

**Grantham School of Electronics** 10-67-RE

1505 N. Western Ave., Hollywood, Calif. 90027

Please send me free literature describing Grantham courses in electronics.

Name \_\_\_\_\_ Age \_\_\_\_\_

Address \_\_\_\_\_

City \_\_\_\_\_ State \_\_\_\_\_ Zip \_\_\_\_\_

I am interested in:  F.C.C. License Course  
 Associate Degree Curriculum

Garrard's new  
 revolutionary  
 Synchro-Lab™  
 Motor  
 locks into the  
 60 cycle current  
 guaranteeing  
 perfectly  
 constant  
 synchronous  
 speed  
 independent  
 of voltage or  
 other variables



The ingenious new Synchro-Lab Motor incorporates the best features of both induction and synchronous motors: instant, full-power start and constant speed regardless of variations in voltage, temperature, stylus pressure or turntable load. It accomplishes this by "locking in" to the 60 cycle line current. It cannot fluctuate. The Synchro-Lab Motor provides dependable driving torque and exceptional freedom from rumble.

Garrard includes this remarkable motor in its new Synchro-Lab Series of automatic turntables which also incorporates a number of other engineering advancements, which will establish new standards of performance for record playing units.

*Just published: Garrard's colorful new Comparator Guide fully describing the Synchro-Lab™ Series and other Garrard Automatic Turntables. Mail coupon for your complimentary copy.*

**Garrard**<sup>®</sup>  
 WORLD'S FINEST

Dept. R-14, Westbury, N.Y. 11590

Please send Comparator Guide.

NAME.....

ADDRESS.....

CITY..... STATE..... ZIP.....

SL 55  
 Automatic Turntable  
 \$59.50

SL 65  
 Automatic Turntable  
 \$79.50

SL 75  
 Automatic  
 Transcription Turntable  
 \$109.50

SL 95  
 Automatic  
 Transcription Turntable  
 \$129.50



Circle 9 on reader's service card

All prices shown less base and cartridge.

# Radio-Electronics

October 1967 VOL. XXXVIII No. 10  
Over 55 Years of Electronics Publishing

6 Hugo Gernsback, 1884-1967

## AUDIO / HI-FI / STEREO

- 32 Cartridge Tracking Tests ..... Raymond E. Ward  
*Phono lab techniques you can easily use in the field*
- 35 Hi-Fi 1968 ..... George Martinson
- 36 Cartridges
- 37 Speakers
- 38 Components and Systems
- 40 Tape Recorders
- 54 The Wider the Band the Higher the Fi? ..... Peter E. Sutheim  
*An argument settled?*

## CONSTRUCTION PROJECTS

- 41 Build—Home Movies Time-Compression Machine ..... Bruce E. Johnson  
*See more in less time with time-lapse photography*
- 44 Build 22 Megohm FET DC Voltmeter ..... Jack Jaques  
*Accuracy at low cost and a millivolt scale too*
- 46 Build Transistor and Diode Mini-Tester ..... James J. Randall  
*Identifies pnp and npn's ... tests leakage and gain ... built-in amplifier helps optimize bias ... all at low cost*

## SERVICING

- 22 In The Shop ... With Jack ..... Jack Darr  
*Service Clinic*
- 48 Repair CB Talk Troubles ..... E. F. Rice & Andy Mueller  
*Logical troubleshooting procedure speeds servicing*
- 52 Radio & TV Troubles ..... Homer L. Davidson  
*Beware of double trouble*
- 57 Signal-Trace FM-Radio and TV Tuners With a Field-Strength Meter ..... John Fitzgibbon  
*Get more mileage out of your FSM ... it's easy*

## ELECTRONICS IN GENERAL

- 50 What's a MOS FET? ..... Gene L. Jackson  
*You'll have to read this to find out*
- 59 R-E Puzzler ..... Edmund A. Braun
- 67 Equipment Report: EICO 711 Receiver

## THE DEPARTMENTS

- |   |                          |
|---|--------------------------|
| 90 Miss-Q                               | 75 New Test Equipment    |
| 66 New Books                            | 16 News Briefs           |
| 76 New CB Equipment                     | 94 Noteworthy Circuits   |
| 80 New Literature                       | 82 Technotes             |
| 78 New Products                         | 95 Try This One          |
| 84 New Semiconductors and Microcircuits | 72 Reader's Service Page |



p 35—IS IT A MAN EGG?



p 54—FOR THE BIRDS

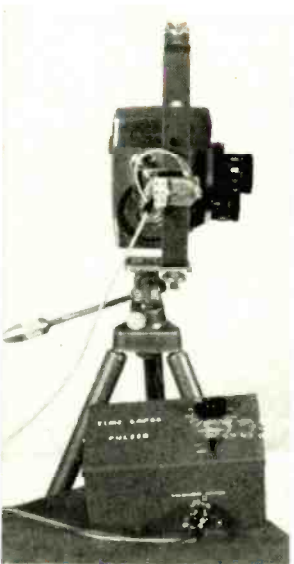

p 41—A YEAR IN A DAY



p 48—EASY CB SERVICE

p 50—NEW TRANSISTORS

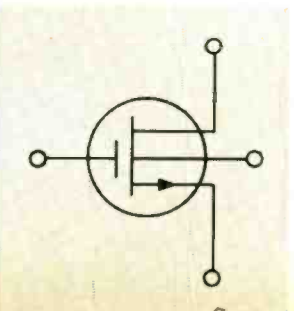

RADIO - ELECTRONICS, OCTOBER 1967, Volume XXXVIII, No. 10, Published monthly by Gernsback Publications, Inc., at Ferry St., Concord, N. H. 03302

Editorial, Advertising, and Executive offices: 154 West 14th Street, New York, N. Y. 10011. Circulation Office, Boulder, Colo. 80302.

Second-class postage paid at Concord, N. H. Printed in U.S.A. One-year subscription rate: U. S. and possessions, Canada, \$5. Pan-American countries, \$6. Other countries, \$6.50. Single copies: 60c. © 1967, by Gernsback Publications, Inc. All rights reserved.

POSTMASTERS: Notices of undelivered copies (Form 3579) to Boulder, Colo. 80302.

## COVER FEATURE



p 32—Simple lab-type tests of stereo phono cartridges you can make in the field to adjust antiskate and stylus pressure for maximum tracking and minimum wear. Also checks for overall operation of channel separation, etc. Equipment shown: oscilloscope, Precision Apparatus, Div. of Dynascan, Model S-55A; turntable, Garrard, Synchro-Lab 75; test record, cartridge, basic amplifier and pressure gauge, Shure, C/PEK-1.



p 44—FET VOLT METER



Member, Institute of High Fidelity. Radio-Electronics is indexed in Applied Science & Technology Index (formerly Industrial Arts Index)

# Announcing... the 'souped-up' transistor.

I.C.E.F. (Inductive Coupled Emitter Feedback)—exclusive patent applied-for Blonder-Tongue circuit gets more mileage from transistors. Gives you more gain, lower noise, better handling capability for your dollar.

Available in these Blonder-Tongue TV/FM signal amplifiers:  
HVB-3P, PS-300, DA-37 and DA-35. Blonder-Tongue  
Laboratories, Inc., 9 Alling St., Newark, N.J. 07102



**BLONDER-TONGUE**

Circle 10 on reader's service card



# SEE WHY

so many  
DeVry-trained  
Men Step Into  
Electronics Jobs  
the Day after  
Graduation!

## EVERY GRADUATE CAN ALSO RECEIVE EMPLOYMENT HELP THROUGH HIS ENTIRE CAREER, AT NO ADDED COST

DeVry's greatest claim to fame is the progress of its graduates. Our aim is to prepare a man so thoroughly that we can recommend him to employers . . . ready to step into a job the day after graduation. If we expect to continue to help employers, our graduates have to be good! That is why we provide top quality instruction—followed by career-long employment service at no added cost.

DeVry's educational programs are designed to prepare men 17-45 in their spare time at home or in any of our three well-equipped, modern resident schools in Chicago, Phoenix or Canada. Why not fill in and mail coupon for free facts today?

*Approved for Veterans.*

### For FREE Information

Lack of technical experience is no barrier to the man who wants to prepare for a career in ELECTRONICS. Send coupon for two FREE booklets and find out why.



Accredited Member of National Home Study Council

**DEVRY INSTITUTE OF TECHNOLOGY**

4141 BELMONT AVENUE, CHICAGO, ILLINOIS 60641

### DeVRY INSTITUTE of TECHNOLOGY

4141 Belmont Avenue, Chicago, Ill. 60641, Dept. RE-10-X

Please give me your two free booklets, "Pocket Guide to Real Earnings," and "Electronics in Space Travel"; also include details on how to prepare for a career in Electronics. I am interested in the following opportunity fields (check one or more):

- |  |   |
|--|---|
| <input type="checkbox"/> Space & Missile Electronics | <input type="checkbox"/> Communications         |
| <input type="checkbox"/> Television and Radio        | <input type="checkbox"/> Computers              |
| <input type="checkbox"/> Microwaves                  | <input type="checkbox"/> Broadcasting           |
| <input type="checkbox"/> Radar                       | <input type="checkbox"/> Industrial Electronics |
| <input type="checkbox"/> Automation Electronics      | <input type="checkbox"/> Electronic Control     |

Name \_\_\_\_\_ Age \_\_\_\_\_

Address \_\_\_\_\_ Apt. \_\_\_\_\_

City \_\_\_\_\_ State or Province \_\_\_\_\_ Zone or Zip Code \_\_\_\_\_

Check here if you are under 16 years of age.

2106 HOME STUDY AND RESIDENT SCHOOL PROGRAMS  
AVAILABLE IN CANADA. SEND FOR DETAILS.

Circle 11 on reader's service card

TURN  
YOUR  
LIVING ROOM  
INTO A  
CONCERT  
HALL!

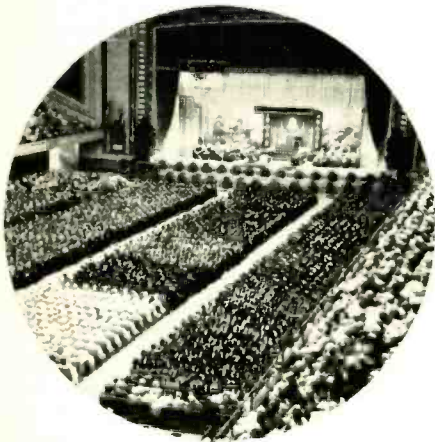

If any speaker can do it . . . an Oxford "Tempo" Hi-Fi speaker can! "Tempo" speakers can reproduce from the lowest frequencies to the most brilliant highs. They feature heavy, ceramic magnets needed for wide-range reproduction, and have Oxford's exclusive "Floating Suspension Surround," a resilient flexible edge which extends the low frequency spectrum without undesirable "hangover."

Try your "test record" (the third movement of Ein Heldenlieben will show up flaws in a speaker about as well as anything) and try it with an Oxford "Tempo" Hi-Fi speaker. You'll be convinced.

Various models available include: 12" with built-in electrical crossover; 12" with built-in whizzer and mechanical crossover; 8" with built-in whizzer and mechanical crossover and a 6 x 9 with built-in whizzer and mechanical crossover.

Write today for full information.

**OXFORD TRANSDUCER**  
COMPANY  
A Division of  
Oxford Electric Corporation

3911 S. Michigan Ave.  
Chicago, Ill. 60653

Circle 12 on reader's service card

## Hugo Gernsback

1884-1967

HUGO GERNSBACK, Editor-in-Chief of RADIO-ELECTRONICS, writer, publisher, educator, inventor and prophet, died August 19 in New York City. His age was 83.

Born in Luxembourg August 16, 1884, Gernsback received an electrical engineering education at the Technikum in Bingen, Germany. He came to the United States in 1904 to exploit an invention—an improved dry battery. A year later he started the *Electro Importing Co.*, the world's first radio supply house.

In 1906 Gernsback founded *Modern Electrics*, the first of a long series of radio and technical magazines. He sold it in 1912, and after a series of combinations, it became one of the ancestors of today's *Popular Science*. He immediately started a larger magazine, the *Electrical Experimenter* (which became *Science and Invention* in 1921). In 1919 he established a purely radio magazine, *Radio Amateur News*. It became *Radio News* in 1920 and still exists as *Electronics World*.

When *Radio News* passed into other hands, Gernsback founded a new magazine, *Radio-Craft* (now RADIO-ELECTRONICS). It first appeared on the stands in July, 1929. Other magazines were *Television* (1929) and *Television News* (1932-33). He also published numbers of other technical, bio-medical and aviation magazines. In 1926 he established the world's first science-fiction magazine, *Amazing Stories* (still in existence). He is known as the father of modern science fiction.

Always a champion of the radio enthusiast, whether amateur, experimenter or professional, Gernsback's crusading for the rights of the early "hams" caused the American Radio Relay League to refer to him at one time as the Father of Amateur Radio. His Wireless League of America, founded in 1909, was an early amateur group. He encouraged and

continued on page 12

## Radio-Electronics

154 WEST 14TH STREET  
NEW YORK, N. Y. 10011

HUGO GERNSBACK, *editor-in-chief*  
M. HARVEY GERNSBACK, *publisher*  
ROBERT CORNELL, *editor*  
Robert F. Scott, *W2PVG, senior editor*  
Thomas R. Haskett, *managing editor*  
Jack Darr, *service editor*  
Peter E. Sutheim, *audio editor*  
I. Queen, *editorial associate*  
Matthew Mandl, *contributing editor*  
Linda Albers, *assistant to editor*  
Wm. Lyon McLaughlin,  
*technical illustration director*  
Bruce Ward, *production manager*  
Adelaide Cassity, *production assistant*  
G. Aliquo, *circulation manager*

Cover by Harry Schlack

RADIO-ELECTRONICS is published by Gernsback Publications, Inc.

Chairman of the Board: Hugo Gernsback

President: M. Harvey Gernsback

Vice President-Secretary: G. Aliquo

### ADVERTISING REPRESENTATIVES

#### EAST

John J. Lamson,  
RADIO-ELECTRONICS, 154 West 14th Street,  
New York, N. Y. 10011, 212-255-7755

#### MIDWEST/N.&S. Car., Ga., Tenn.

Robert Pattis, the Bill Pattis Co., 4761 West  
Touhy Ave., Lincolnwood, Ill. 60646,  
312-679-1100

#### W. COAST/Texas/Arkansas/Oklahoma

J. E. Publishers Representative Co., 8380  
Melrose Ave., Los Angeles, Calif. 90069,  
213-653-5841; 420 Market St., San Francisco,  
Calif. 94111, 415-981-4527

#### UNITED KINGDOM

Publishing & Distributing Co., Ltd., Mitre  
House, 177 Regent St., London W.1, England

**SUBSCRIPTION SERVICE:** Send all subscription correspondence and orders to RADIO-ELECTRONICS, Subscription Department, Boulder, Colo. 80302. For change of address, allow six weeks, furnishing both the old and new addresses and if possible enclosing label from a recent issue.

**MOVING?** Or writing about subscription? Be sure to fill out form below.

For FASTEST service on address change, missing copies, etc., attach old mailing label in first space below. Otherwise please print clearly your address as we now have it.

OLD ADDRESS (Attach old label if available)

Name .....

Address .....

City ..... State .....

Zip Code .....

#### NEW ADDRESS

Name .....

Address .....

City ..... State .....

Zip Code .....

Mail to: RADIO-ELECTRONICS  
Subscription Dept. Boulder, Colo. 80302



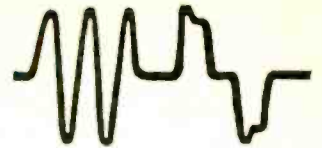

## When you need a stable capacitor...

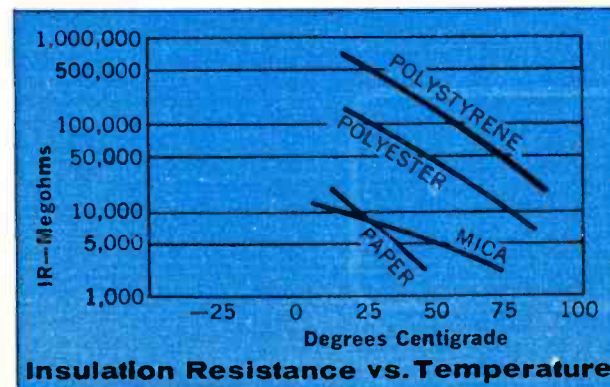
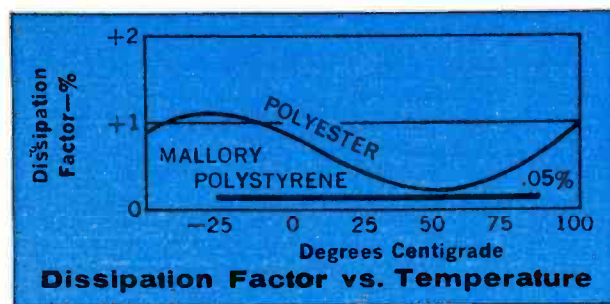
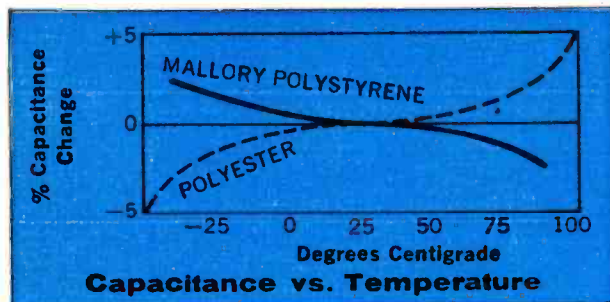
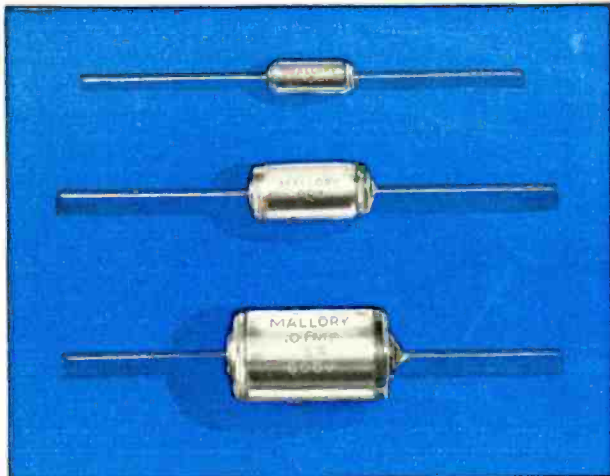

Temperature makes most capacitors wander. For electrolytics, capacitance goes down when temperature gets colder, goes up when things get hot. But this usually doesn't cause trouble, because most electrolytic applications are in filtering—and as long as you have low enough AC impedance, you get the filtering you need. Where drift can bring problems is in tuned circuits, timing and differentiator circuits; here you've got a paper, film, ceramic or mica capacitor, in the fractional-microfarad range. If it changes value due to temperature variations or just plain old age, you're going to have some headaches.

Today's tip: when you need extra stability, try the *new* Mallory polystyrene capacitors. They're the most stable you've ever seen. They look different, and they act different. They're made of a unique kind of stretched polystyrene film and high purity aluminum foil, wound up in a compact roll and then fused together in a self-sealed case of solid clear plastic.

What's extra special about these new capacitors is the way they hold their original microfarad value while temperature varies all over the lot. Temperature coefficient is considerably lower than that of polyester film capacitors—under 150 parts per million per degree C. And it's negative—which means that instead of going up with temperature, capacitance goes down. This is the direction you need to change capacitance in order to compensate for the effect of temperature on the inductive part of a tuned circuit. From  $-10^{\circ}\text{C}$  to  $+70^{\circ}\text{C}$ , their *total* capacitance change is less than 1.3%. And brother, that's *stable!*

And that's not all. These little dandies don't grow old. They hold their characteristics month after month. You just connect 'em and forget 'em.

One more thing. Mallory Polystyrene Capacitors have the lowest dielectric loss in the business. Their dissipation factor (similar to power factor, a measure of efficiency as a capacitor) is extremely low . . . only 0.05%, which is a small fraction of that of other capacitors. And it stays at this low value over the whole temperature range. This means that they're high Q capacitors, ideal for tuned circuits. And their insulation resistance is way higher than polyester, mica or paper capacitors.

In case you were wondering how much dough you would have to lay out to get such wonderful capacitors—here's the best news of all. They are really low priced. You can get them in values from 5 pF to .01 mfd, all rated 600 volts, from your Mallory Distributor. See him soon—and ask for your copy of the 1967 Mallory General Catalog. Mallory Distributor Products Company, a division of P. R. Mallory & Co. Inc., Indianapolis, Indiana 46206.

# Discover the excitement of learning Electronics with training kits NRI sends you

## New Achievement Kit Custom Training Kits "Bite Size" Texts

Only NRI offers you this pioneering method of "3-Dimensional" home-study training. It's the result of more than half a century of simplifying, organizing, dramatizing subject matter. As an ambitious man you can effectively learn the Electronics field of your choice the NRI way. But NRI training is more than kits and texts. It's personal services, too, which have made NRI a 50-year leader in the home-study field.

### YOU GET MORE FOR YOUR MONEY FROM NRI

Everything that you see here is included in just one NRI course. Other courses are equally complete, yet you'll be surprised at the low cost. Text for text, kit for kit, dollar for dollar—your best home study buy is NRI.

#### Available Under **NEW GI BILL**

If you served since January 31, 1955, or are in service, check GI line in postage-free card.



*Earn \$4 to \$6 an hour  
spare or full time in*  
**TV-RADIO  
SERVICING**

Want to earn extra money? Looking for a good paying job? Interested in your own full-time business? Radio-TV Servicing is the branch of Electronics offering all these opportunities. In addition to teaching you the facts, NRI shows you how to earn while you learn.

You can learn quickly how to install, maintain and service tube and transistor home and auto radios, TV sets (including booming Color TV), hi-fi and stereo, public address systems. Like thousands of others, you can be earning \$4 to \$6 an hour in spare-time starting soon after you enroll.

*There's glamor and  
success awaiting you in*  
**BROADCASTING—  
COMMUNICATIONS**

Good paying, fascinating positions await competent Communications Operators and Technicians. Broadcast stations, commercial stations, ships, aircraft, land vehicles all need men who know how to maintain and repair transmitting and receiving equipment. With closed-circuit TV, Facsimile, Microwave, Radar, Telemetry and all the communications needs of the Space Age, you can see how important training in this field has become. NRI training includes preparation for your First Class Radiotelephone FCC License.

*And you must pass the FCC exam  
or NRI refunds your tuition in full!*

*Move ahead in America's  
fast moving industry as an*  
**ELECTRONICS  
TECHNICIAN**

There is a serious shortage of qualified Electronics Technicians. Electronics has found its way into hundreds of areas not even dreamed of ten years ago: offices; manufacturing; medical and dental uses; transportation; space exploration; government and military equipment . . . there's no end of opportunity for trained men. This course stresses the basic principles around which most Electronic devices are built; prepares you for many current job openings. Prepare now. Learn Automation, computers, data processing, ultrasonics, telemetry. Whatever your interest in Electronics, you'll find an NRI training plan for you. Check the course of most interest to you on the postage-free card and mail it today for your free NRI Catalog. No obligation. No salesman will call. NATIONAL RADIO INSTITUTE, Washington, D. C. 20016.



**More than  
50 years of leadership  
in Electronics Training**

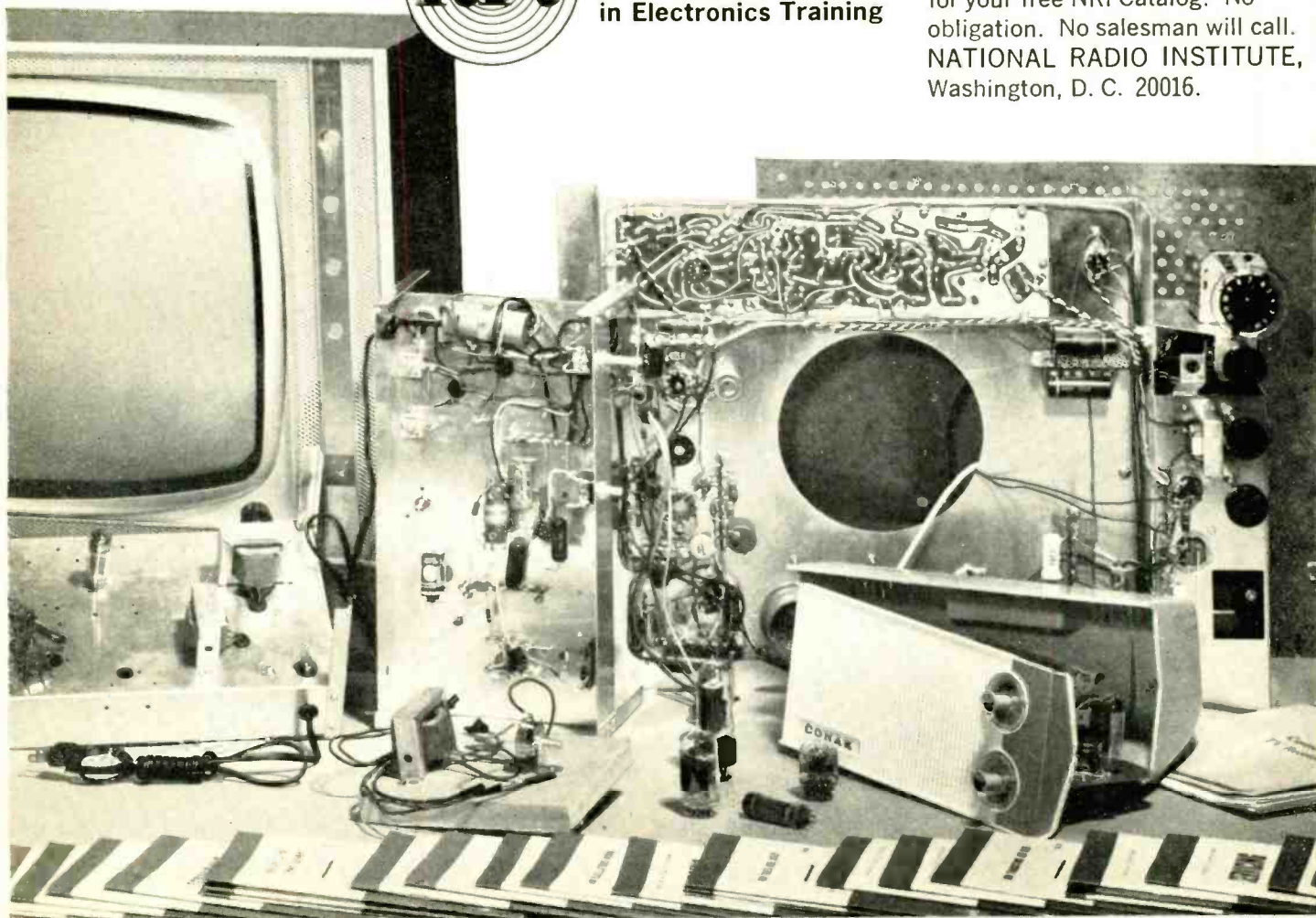

**For home recording,  
stereo taping,  
public address work...**



**Eliminate  
background  
noise, feedback,  
with the  
TURNER 500  
Cardioid.** Model 500 List Price \$84.00

The Turner Microphone Company—Cedar Rapids, Iowa

Circle 14 on reader's service card

HUGO GERNSBACK

sponsored the engineers' association that later became the Institute of Radio Engineers (now IEEE) and tried to establish a radio service technicians' organization, the Official Radio Service Men's Association (ORSMA).

As inventor, Gernsback obtained some 80 patents, including one on the compression-type capacitor (the principle used in trimmers) and the use of bone conduction as an aid to hearing.

Best known to the general public as a prophet, Gernsback's most striking prediction was the description of radar, which appeared in the *Modern Electrics* serial "Ralph 124C 41+." In the same story he predicted space travel, microfilm, two-way television, germicidal rays, tape recording (with quarter-inch tape!), night baseball, artificial silk and wool, and fluorescent lights.

He was the author of three books, *The Wireless Telephone* (1908), *Radio for All* (1922) and *Ralph 124C 41+*, which appeared in book form in 1925. A second edition was published in 1950 and a paperback edition was put out by Crest Books in 1958. A Russian translation was published in 1964.

In 1928, his radio station, WRNY in New York City, was the first to broadcast television on a regular schedule. The miniature pictures were not considered entertainment quality even in that day, but were faithfully received by more than 2,000 amateur viewers.

He leaves four children, Madelon of Rome, Italy; M. Harvey of New York (publisher of RADIO-ELECTRONICS); Mrs. Tina Baer of New York and Mrs. Jocelyn Neichin of Monsey, N.Y., seven grandchildren and one great-grandchild.

*A complete story of the many-sided genius who was Hugo Gernsback will appear in the next issue.*

The Correspondence column which normally would have appeared here will be in next month.

# LOOK!

## A New Electronics Slide Rule with Instruction Course

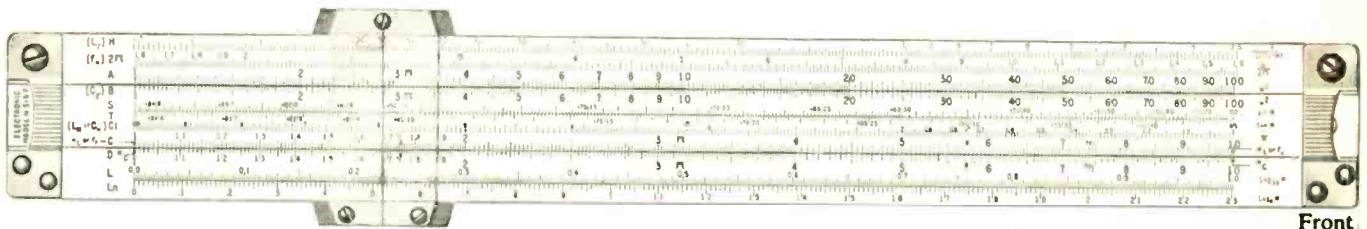

Front



Back

This amazing new "computer in a case" will save you time the very first day. CIE's patented, all-metal 10" electronics slide rule was designed *specifically* for electronic engineers, technicians, students, radio-TV servicemen and hobbyists. It features special scales for solving reactance, resonance, inductance and AC-DC circuitry problems . . . an exclusive "fast-finder" decimal point locator . . . widely-used formulas and conversion factors for instant reference. And there's all the standard scales you need to do multiplication, division, square roots, logs, etc.

Best of all, the CIE Slide Rule comes complete with an Instruction Course of four **AUTO-PROGRAMMED** lessons. It includes hundreds of illustrations, diagrams and practice problems. You'll learn ingenious short cuts . . . whip through exacting electronics problems quickly and accurately. This course alone is worth far more than the price of the entire package!

Electronics Slide Rule, Instruction Course, *and* handsome, top-grain leather carrying case . . . a \$50 value for less than \$25. Send coupon for **FREE** illustrated booklet and **FREE** heavy vinyl Pocket Electronics Data Guide. Cleveland Institute of Electronics, 1776 E. 17th St., Dept. RE-145 Cleveland, Ohio 44114.

\*TRADEMARK

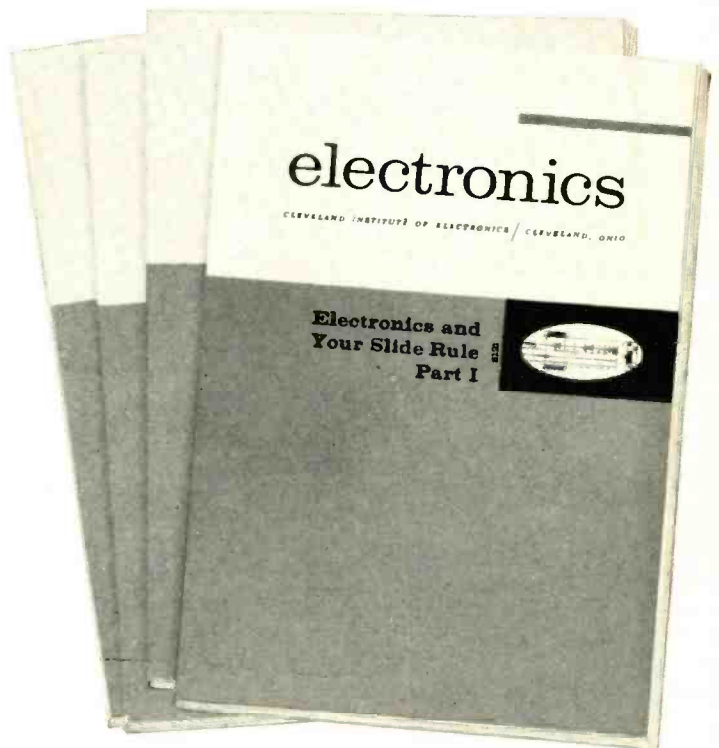

**GET BOTH FREE!**



**ELECTRONICS**

**SLIDE RULE**

**Send coupon today** →

### Cleveland Institute of Electronics

1776 E. 17th St., Dept. RE-145 Cleveland, Ohio 44114

Please send **FREE** Illustrated Booklet describing your Electronics Slide Rule and Instruction Course.

**SPECIAL BONUS!** Mail coupon promptly . . . get **FREE** Pocket Electronics Data Guide too!

Name \_\_\_\_\_

(PLEASE PRINT)

Address \_\_\_\_\_ County \_\_\_\_\_

City \_\_\_\_\_ State \_\_\_\_\_ Zip \_\_\_\_\_

A leader in Electronics Training . . . since 1934.

Circle 15 on reader's service card

**CIRCUIT ANALYZERS**

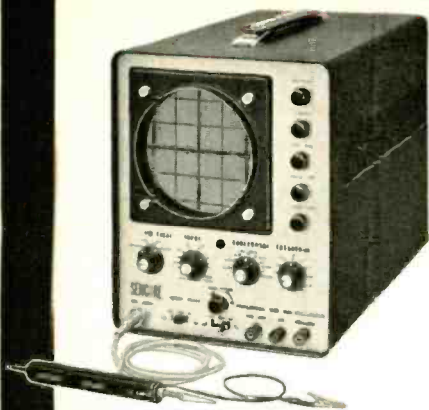

PS 127—Wide Band 5" Oscilloscope with direct reading P to P volts. **\$199.50**



SM 112B—Combination VTVM-VOM with automatic scale indication. **\$89.95**



SS 137—Sweep Circuit Analyzer for both black & white and color TV. **\$94.50**



FS 134—Field Strength Meter covers all VHF and UHF channels plus FM. **\$199.50**

**PICTURE TUBE TESTERS & REJ.**



CR 143—CRT Champion Deluxe CRT checker and rejuvenator. A must for accurate color CRT testing. **\$99.50**



CR 13—CRT Cadet CRT checker and rejuvenator. Easy to set-up, fast to use. **\$79.95**

**COLOR GENERATORS**



CG 10—Lo Boy Standard Color Bar Generator—battery operated. **\$89.95**



CG 12—Lo Boy Standard Color Bar Generator—AC operated and 4.5 mc tuning crystal. **\$109.95**



CG 141—Color King Standard Color Bar Generator with exclusive TEMP CONTROL for absolute stability. **\$149.95**



CA 122B—Deluxe Color Circuit Analyzer for black & white and color. **\$187.50**

**NEW  
for 1967**

*the  
most complete  
line of quality  
time-saving test  
instruments by*

**SENCORE**

NO. 1 MANUFACTURER OF ELECTRONIC MAINTENANCE EQUIPMENT

Here's the big SENCORE line-up for '67. All new, all improved. Each instrument is the finest in the field, designed, engineered and built to save time, make you money. Every instrument is

triple tested for guaranteed accuracy. Compact, portable, rugged. All steel encased. Priced right—check and compare. SENCORE... your best buy, always.

**TRANSISTOR TESTING**



**TR 135**—In-Circuit, Out of Circuit Transistor Tester that works every time. **\$89.50**



**TR 115**—Out of Circuit Transistor Tester. Easy to use. **\$24.95**



**BE 124**—Battery Eliminator for fast repair of transistor radios. **\$29.95**

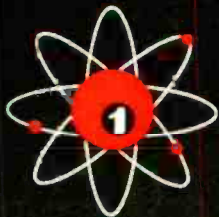

**MULTIPLEX**



**MX 129**—Deluxe Multiplex Generator for fast repair of FM Stereo receivers. **\$199.50**

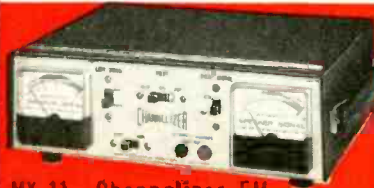

**MX 11**—Channelizer FM Stereo Multiplex Generator simplifies stereo servicing. **\$99.50**

**SUBSTITUTION**

**RC 144**—Handy 36 Resistor-Capacitor substitution unit—lower than the cost of the parts. **\$14.95**



**RC 145**—Handy 53 Resistor, Capacitor and Electrolytic substitution with full protection. **\$34.95**



**RC 146**—Handy 75 Resistors, Capacitors, Electrolytics, Power Resistors, and Universal Silicon and Selenium Rectifiers at your fingertips. **\$44.95**



**TUBE TESTERS**

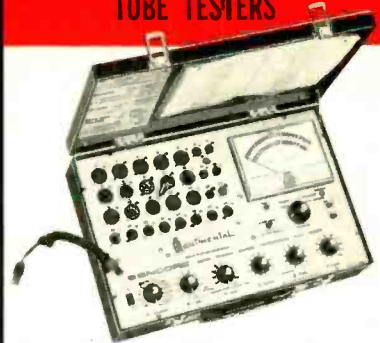

**MU 140** Continental Mutual Conductance Tube Tester—also speedy Mighty Mite tester with first three controls. **\$179.50**



**TC 13.1**—Semi-Automatic Tube Tester for you or your customer. Easy to operate—sensitive. **\$99.50**



**TC 142**—New Mighty Mite V speedy and sensitive in home or shop tube tester. **\$74.50**

**FC 147**—Filament Checker. A must for series string filament testing. **\$4.95**



**BE 113**—Dual TV Bias Supply. Two 0 to 20 volts DC supplies for alignment or AGC trouble shooting. **\$14.95**



**FREE**  
SEND  
FOR NEW 1967  
SENCORE  
CATALOG



SENCORE, INC. 426 S. Westgate Dr., Addison, Ill. 60101

Please rush me your FREE 1967 catalog, showing all your new instruments.

NAME \_\_\_\_\_ (Please print)

ADDRESS \_\_\_\_\_

CITY \_\_\_\_\_ STATE \_\_\_\_\_ ZIP \_\_\_\_\_



**RCA sun bottle:** First gas lasers to produce intense rays of ultraviolet light continuously up to 1000 hours, to be used to solve mysteries of life.



**CB hits the road:** Truck users will soon be able to buy GMC trucks equipped with factory-installed CB transceivers and antennas. Units are smaller than a cigar box. Communications gear will be supplied by Lafayette Radio Electronics Corp., to GMC Truck & Coach Division.

# NEWS BRIEFS

**Micromodule highway control system:** Road maps of the future may be compressed into small electronic circuits like the one in the girl's hand. Thus a motorist could travel to his destination without maps or route signs; vehicle control would come from the micromodules. General Motors has started developmental program toward this end under a Federal contract. System would also use roadside equipment.

**Resistor breakthrough:** Packing up to one ter-ohm (one million megohms) is a resistor small enough to fit under your fingernail. Usable up to 212° F. Manufactured by Pyrofilm Resistor Co.



**Lying down on the job:** Well, not exactly. Stormy winds up to 85 miles an hour knocked over this telephone booth. Man in the photo called repair service to report the incident. In spite of the accident, equipment was still operating satisfactorily.





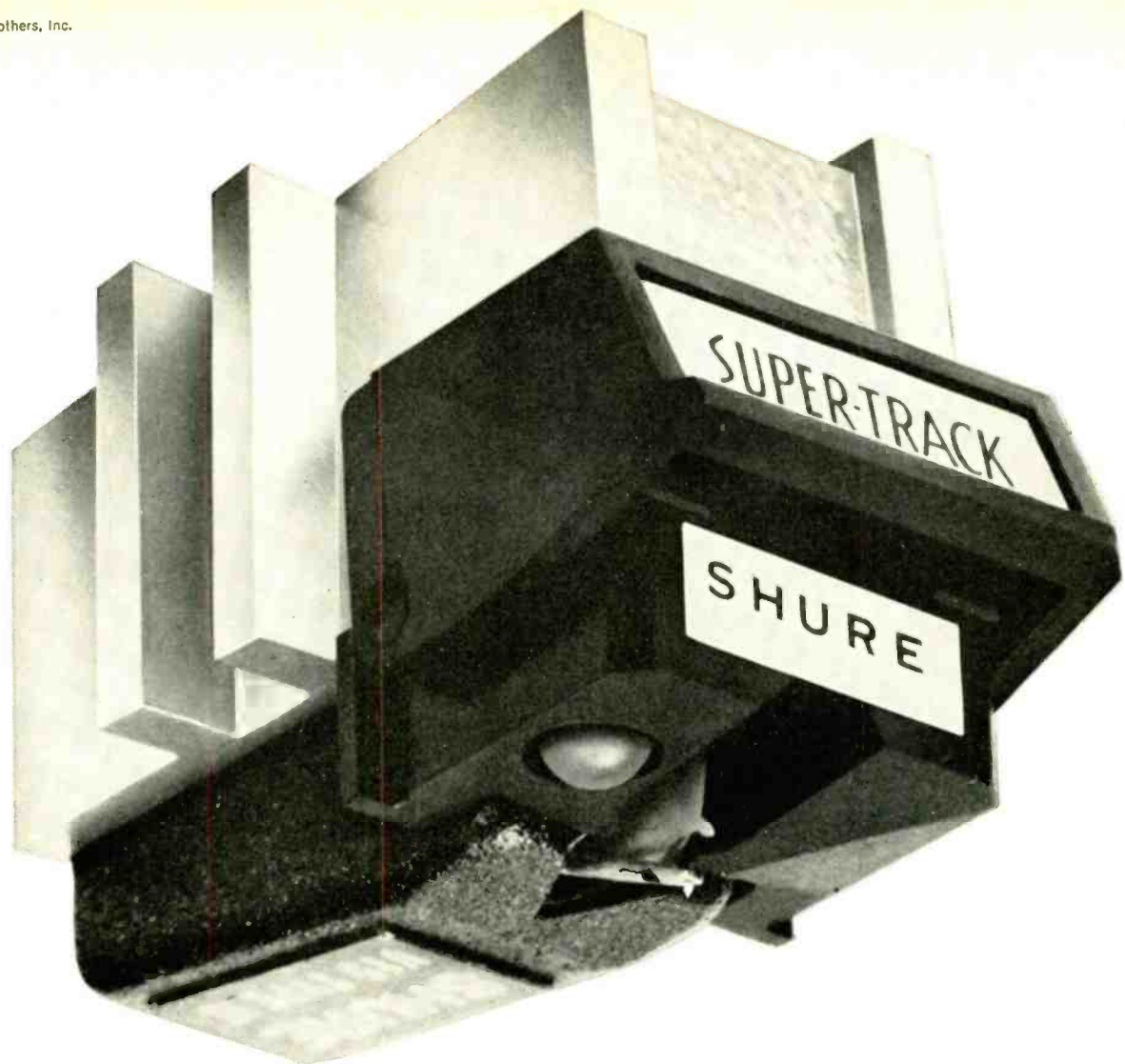

**SINGULAR!**  
in no other way can  
\$67.50 create such a  
hearable sound improvement

The Shure V-15 Type II costs about \$30.00 more than "second-echelon" (good) cartridges. This same \$30.00 would barely pay for a different finish in loudspeakers; or provide minimal convenience-type improvements in a good quality turntable; and would have virtually no noticeable sound difference if invested in a better amplifier. With the V-15 Type II, you will *HEAR* a difference, always.

World-wide, critics say that all of your recordings will sound better and last longer when played with the revolutionary Shure V-15 Type II Super-Trackability phono cartridge.

Independent testing organizations say it is alone in its ability to track passages which have been cut at a sufficiently high recording velocity to insure precise and definitive intonation, full dynamic range, and optimum signal-to-noise ratio . . . at one gram (or less) force!

**WRITE FOR COMPLETE LITERATURE**, or send \$3.95 for the definitive Shure trackability test record "An Audio Obstacle Course". (Record is free with a V-15 Type II.) Shure Brothers, Inc., 222 Hartrey Ave., Evanston, Illinois 60204.

# There's more than one road to success.

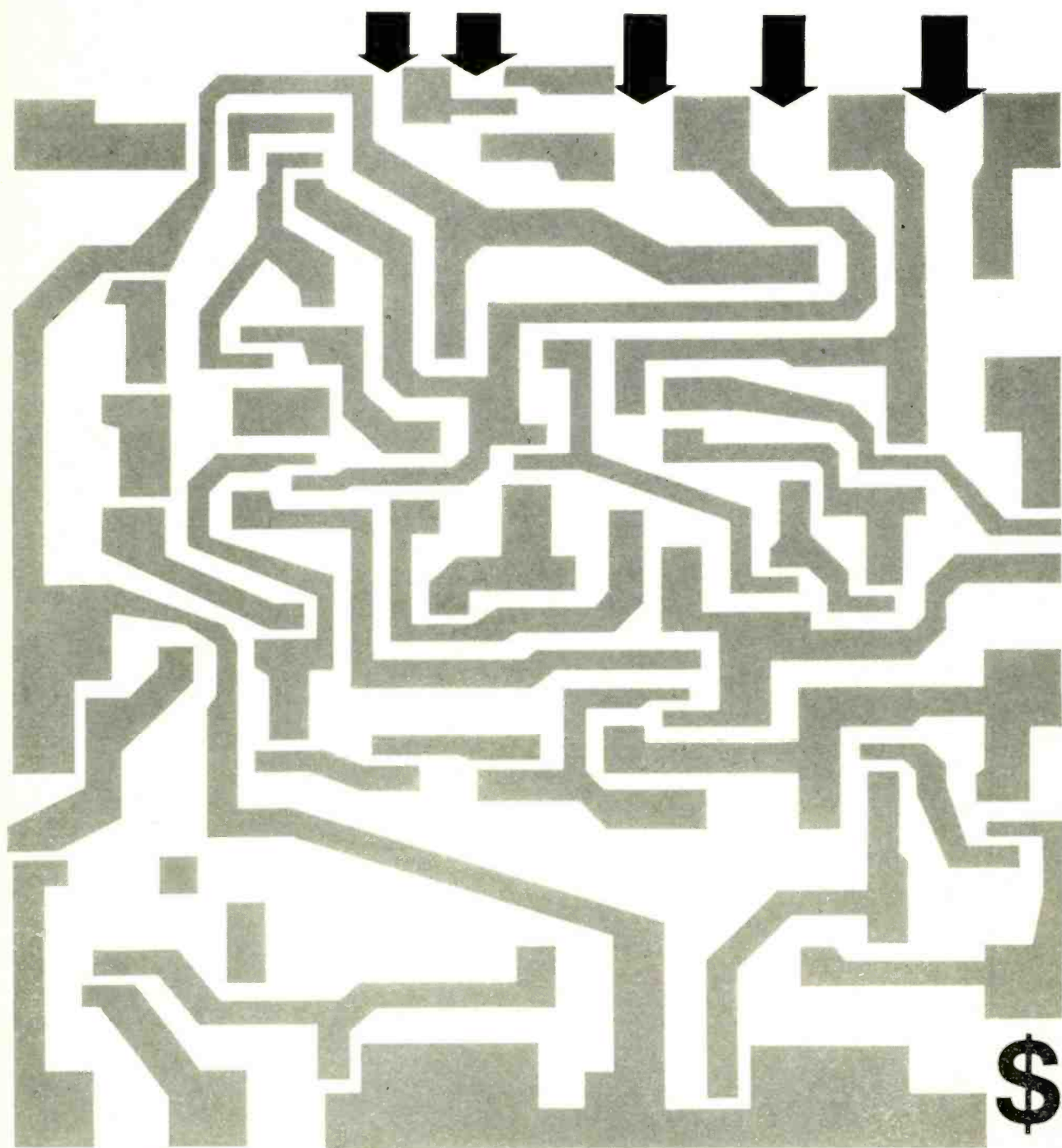

An integrated circuit enlarged several thousand times

## RCA Institutes can help find the one best for you!

Are you trying to find your way through a maze of career possibilities? Find out how RCA Institutes can start you on your way toward a well paying job in electronics. Send the attached card today!

# Learn electronics at home faster, easier, almost automatically— with RCA AUTOTEXT

Are you just a beginner with an interest in the exciting field of electronics? Or, are you already earning a living in electronics and want to brush-up or expand your knowledge in a more rewarding field of electronics? In either case, AUTOTEXT, RCA Institutes' own method of Home Training will help you learn electronics more quickly and with less effort, even if you've had trouble with conventional learning methods in the past.

## THOUSANDS OF WELL PAID JOBS ARE OPEN NOW TO MEN SKILLED IN ELECTRONICS!

Thousands of well paid jobs in electronics go unfilled every year because not enough men have taken the opportunity to train themselves for these openings. RCA Institutes has done something positive to help men with an aptitude and interest in electronics to qualify for these jobs.

## HOME STUDY CAN TRAIN YOU FOR REWARDING CAREER OPPORTUNITIES

To help fill the "manpower gap" in the electronics field, RCA Institutes has developed a broad scope of Home Training courses, all designed to lead to a well paying career in electronics in the least possible time. You also have the opportunity to enroll in an RCA "Career Program" exclusively created to train you quickly for the job you want! Each "Career Program" starts with the amazing AUTOTEXT Programmed Instruction Method. And, all along the way, your program is supervised by RCA Institutes experts who become personally involved in your training and help you over any "rough spots" that may develop.

## VARIETY OF KITS ARE YOURS TO KEEP

To give practical application to your studies, a variety of valuable RCA Institutes engineered kits are included in your program. Each kit is complete in itself, and yours to keep at no extra cost. You get the new Programmed Electronics Breadboard for limitless experiments, including building a work-

ing signal generator, multimeter, and a fully transistorized superheterodyne AM receiver.

## ONLY FROM RCA INSTITUTES— TRANSISTORIZED TV KIT— VALUABLE OSCILLOSCOPE

All students receive a valuable oscilloscope. Those enrolled in the Television program receive the all-new transistorized TV Kit. Both at no extra cost and only from RCA Institutes.

## CHOOSE THE "CAREER PROGRAM" THAT APPEALS MOST TO YOU

Start today on the electronics career of your choice. Pick the one that suits you best and mark it off on the attached card.

- Television Servicing
- Telecommunications
- FCC License Preparation
- Automation Electronics
- Automatic Controls
- Digital Techniques
- Industrial Electronics
- Nuclear Instrumentation
- Solid State Electronics
- Electronics Drafting

## ADVANCED TRAINING

For those already working in electronics, RCA Institutes offers advanced courses. You can start on a higher level without wasting time on work you already know.

## UNIQUE TUITION PLAN

With RCA Institutes Training, you progress at your own pace. You only pay for lessons as you order them. You don't sign a long-term contract. There's

no large down-payment to lose if you decide not to continue. You're never badgered for monthly payments. Even if you decide to interrupt your training at any time, you don't pay a single cent more.

## CLASSROOM TRAINING ALSO AVAILABLE

If you prefer, you can attend classes at RCA Institutes Resident School, one of the largest of its kind in New York City. Coeducational classroom and laboratory training, day and evening sessions, start four times a year. Simply check "Classroom Training" on the attached card for full information.

## FREE PLACEMENT SERVICE, TOO

In recent years, 9 out of 10 Resident School students who used the Free Placement Service have been placed before or shortly after graduation. This Service is available to Home Study students.

**SEND ATTACHED POSTAGE PAID  
CARD TODAY. FREE DESCRIPTIVE  
BOOK YOURS WITHOUT OBLIGATION.  
NO SALESMAN WILL CALL.**

All RCA Institutes courses and programs are approved for veterans under the New G.I. Bill.

**RCA INSTITUTES, INC.** Dept. ZRE-07  
350 West 4th Street  
New York, N.Y. 10014



The Most Trusted Name In Electronics

# Hickok



**770A OSCILLOSCOPE** — General purpose Industrial oscilloscope with calibrated 4MHz DC vertical amplifier, 18 direct reading calibrated sweep rates from 1 $\mu$  sec/cm to 0.5 sec/cm, choice of free-running, driven or automatic sweep modes. Flat-faced 5" post-accelerated CRT.  
\$635.00

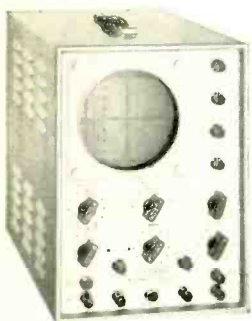

**677 OSCILLOSCOPE** — Low cost utility and service instrument with 5" CRT. Vertical amplifier response within 3db from 5Hz to 4.5MHz. Built-in calibrator simplifies peak-to-peak measurements. Horizontal sweep has preset positions for TV vertical and horizontal signals.  
\$219.95



**209C VTVM** — Combination VOM, VTVM and Capacitance meter with giant 5" meter display. 8DC ranges (including 0.5 volt range), 7 AC ranges with response to 200MHz, 7 capacitance ranges. Light loading probe (11Meg, 5pF).  
\$184.50



**470A "UNI-SCALE" VTVM** — Unique design reduces number of scales for easier, faster readings. AC and DC values read from the same scale. High-sensitivity (0.5 volt AC-DC). Single-unit probe. Input loading only 17Meg-ohms at 150pF.  
\$89.50



**455A VOM** — Measures AC/DC voltage, ohms, current. Burnout-proof, using Hickok's exclusive overload cut-out and protection system, provides complete safety for meter movement and components. Color-coded, easy-to-read dial, 20,000 ohms/volt AC and DC.  
\$89.50

## In the Shop . . . With Jack

By JACK DARR

IF YOU'VE LOOKED IN THE BACK OF any PA amplifiers lately, you've seen taps on the output transformer marked 70.7 or even 100.5 volts, beside the old faithful 4-, 8-, 16- and 32-ohm taps. These extras have their uses; not in standard short-run jobs, but when you need 'em, you need 'em bad. They are used for shipping sound over long distances without too much loss. Useful in jobs like factory sound systems, football fields, and any other outdoor work where your speakers must be a long way apart. Now let's see why.

### Problem

Take a PA job with 30 watts output, and the horns about 200 feet from the speaker in each direction. Our problem is getting the stuff there without losing it along the way. If we hook the speakers to the 8-ohm taps of the output transformer, we are using a low-impedance output.

Now, exactly what does this mean? Low-impedance lines have low voltage and high *current*. We can get the audio power to the speakers, if we use large wire: obviously, this costs more than small wire. Plugging in some figures, for a 30-watt output at 8 ohms, we'd get  $P = I^2 Z$ , which in this case is  $30 = I^2 8$ , or something like 1.94 amps. To get over long distances with this kind of current, we'll wind up with No. 10 or 12 wire. It must be big enough to carry heavy current without hardly any line loss.

This column is for your service problems—TV, radio, audio or general and industrial electronics. We answer all questions individually by mail, free of charge, and the more interesting ones will be printed here.

If you're really stuck, write us. We'll do our best to help you. Don't forget to enclose a stamped, self-addressed envelope. Write: Service Editor, Radio-Electronics, 154 West 14th Street, New York 10011.

There's another way. The power companies carry large amounts of power over very long distances without too much loss, simply by stepping up the *voltage*, which reduces the current. Power in these circuits is always  $E \times I$ ; if we make E bigger, we make I smaller—and vice versa. The power, which is the *product* of the two, comes out the same at the other end.

### Solution

So, if we step up our audio voltage to 70.7 or 100.5 volts, we can ship it much further, over smaller wire, and still get to the speakers with a lot of wallop. In this example, changing the voltage to 100.5 would give us  $30 = I^2 100.5$ , or a lot less current. From 1.94 amps down to 0.54 amp, which is considerable.

This method requires matching transformers at each speaker, to get the high line impedance down to match the speaker voice coils. You can get these transformers in almost any size and wattage rating. If the system uses a lot of speakers, the transformers can be used to set the audio level at each speaker. You simply pick out the tap on each transformer which gives you the power you need. To make things simpler, many of the transformers are marked in *watts output*. In much the same manner as the 117-volt ac power line, a constant voltage is always available and more or less power can be drawn, provided that the generator's (amplifier's) power rating is not exceeded.

To set up a system in a large factory or arena, which takes in low and high ambient noise levels or where some horns or speakers have to cover large outdoor areas while others serve indoors, you can do it all with the same wiring. You can set up, say, 20 speakers at 5 watts each, by selecting the right taps on the transformers. Then, the outdoor horns can be set up to deliver up to 25 watts each.

The total sound-power output is 100 watts for the twenty 5-watters and whatever the total of the horns comes out. Say there were two 25-watt horns; this would make a total, for the

continued on page 26

The closer you get...  
the better you like  
the new  
**E-V Model 631**  
dynamic  
microphone!

 There's just one way to learn how good—or how bad—a microphone really is. Try it. So let's put the new Electro-Voice Model 631 omnidirectional dynamic microphone through its paces.

#### Based on Broadcast Design

The shape of the new 631 may seem familiar—for good reason. This unique microphone is a direct descendant of the E-V 635A seen often on every major TV network, and fast becoming radio and TV's most popular microphone. Recording and film studios also found that the 635A could replace microphones costing hundreds of dollars more. But it was performance, not price, that convinced them. The 631 enjoys the same basic advantages, especially tailored to general purpose applications.

#### Top Performance Sealed In

Listen critically to the 631. Smooth, flat response with plenty of output (it wouldn't be an E-V microphone otherwise). But unlike any other microphone with a switch in the body, this performance is sealed in. There are no openings of any kind to leak and degrade bass response. It's an entirely new concept of microphone switching. We call it Uniseal™. It guarantees that every 631 will maintain its like-new performance for years.

#### Ends Switching Problems Forever

Don't try this on any other microphone, but you can peel off the 631 switch actuator. Underneath that smooth, solid case is a magnetically operated reed relay, forever safe from dirt and corrosion. The mag-

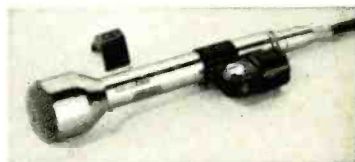

net is in the removable actuator. In the "Off" position, the magnet closes the switch contacts, shorting the 631 output. In the "On" position, the contacts open. And when the actuator is removed, the microphone stays on. There is nothing more versatile or dependable. The Uniseal switch is exclusive with Electro-Voice.

#### Protected Four Ways

Pick up the 631. Light, but not flimsy. Good balance. A joy to use in handheld applications, and easy to mount anywhere. If you could look inside the 631 you would find a 4-stage acoustic filter that traps dirt and magnetic particles before they can get to the element. And the same filter makes it almost impossible to blast or "pop" the 631—even when performers work ultra-close.



#### Unique "Nesting" Construction

Behind the filter is a most sophisticated dynamic element. The diaphragm is made of E-V Acoustalloy® and just about indestructible. The entire element is designed so that internal parts "nest" inside each other, making a solid assembly almost impervious to shock. To cut down on mechanical noise, the complete assembly is cushioned by viscous vinyl.

#### Easy to Install

To install a 631, just slip it into the 3/4" stand clamp provided (it also fits all other 3/4" accessory mounts). Next, plug in the cable. Note the sturdy pin-type connectors for more positive contact, especially on the high impedance model. Note also the heavy broadcast-type cable that withstands heaviest abuse.

The 631 is available in satin chrome or matte satin nickel finish for just \$60.00 list (less normal trade discounts). Or you can buy it in your choice of custom carrying cases, complete with standard phone plug for slightly more. Want more details? Just write. Or better yet, inspect the 631 first hand at your E-V microphone headquarters. The closer you look, the better you like it!

**ELECTRO-VOICE, INC.**, Dept. 1072E,  
613 Cecil Street, Buchanan, Michigan 49107



high fidelity systems and speakers • tuners, amplifiers, receivers  
• public address loudspeakers • microphones • phono needles  
and cartridges • organs • space and defense electronics

Circle 20 on reader's service card

# Winegard Introduces Super Compact Total Design Electronic SUPER COLORTRONS

Five 82-Channel Models  
Four VHF/FM Models  
Three UHF Models

...so revolutionary in design and concept,  
they have 7 patents and patents pending

82-Channel Super Colortron  
Model SC-82; \$54.95

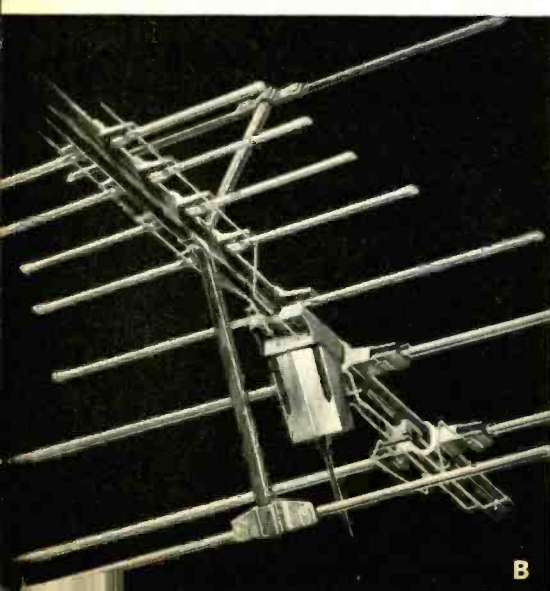
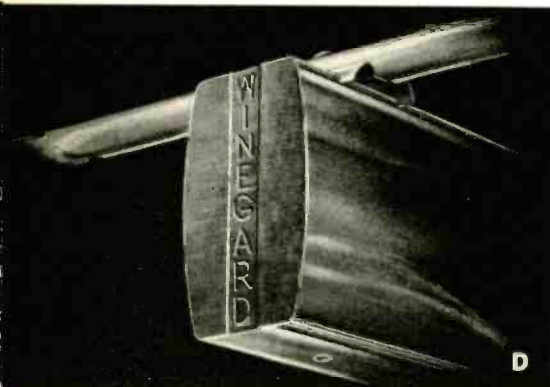
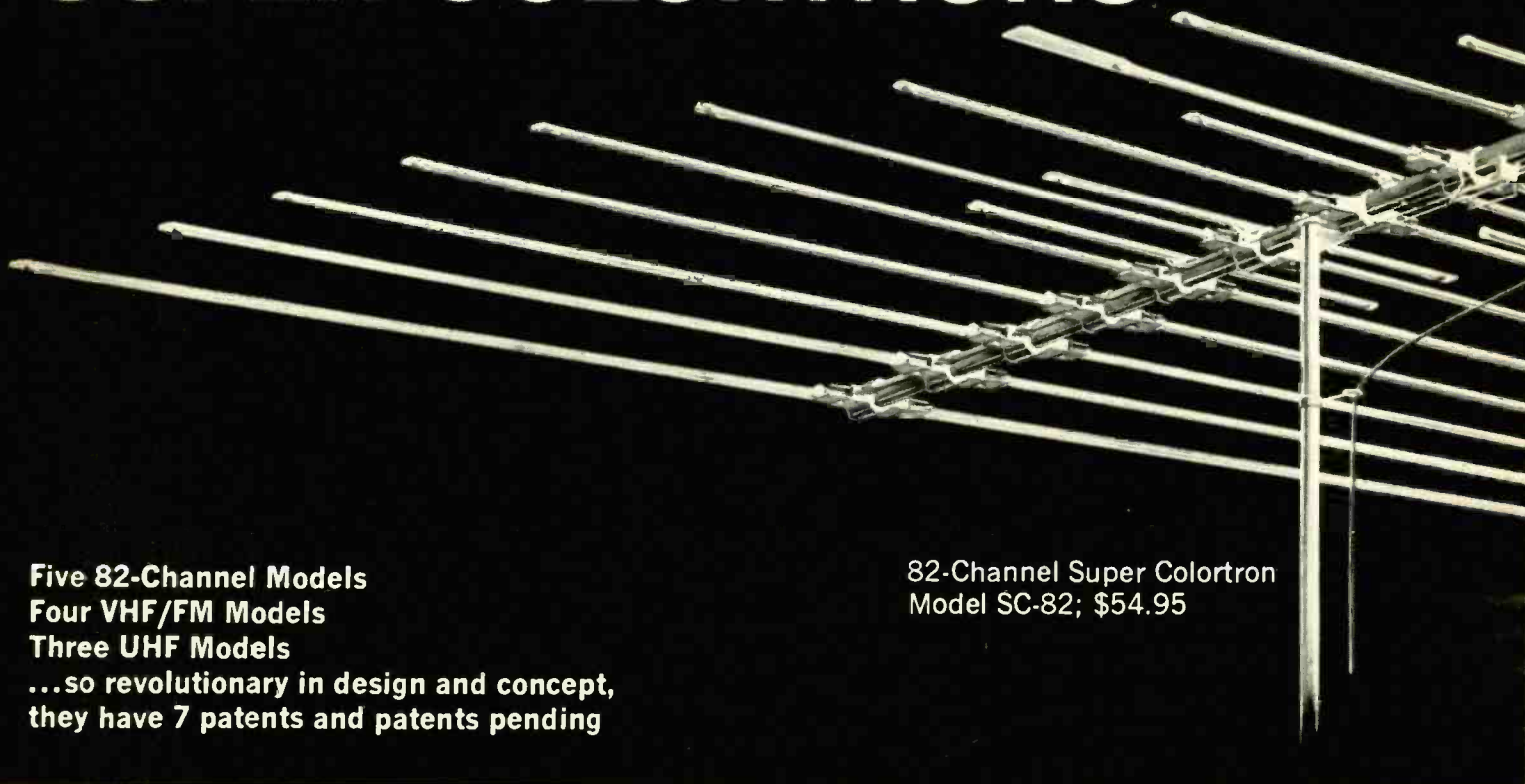

## The World's First Total Design Antennas

New antennas come and go. But there's never been an antenna like the amazing Winegard Super Colortron. 12 models in all—totally designed with more exclusive electronic, construction and performance features than all other antennas combined. It's taken us a while to create and develop and perfect the Super Colortron. But it was worth the time. See for yourself. Read about the Super Colortron's exclusive features. Then call your Winegard distributor. Or write for full color, 8-page brochure.

### (A) Total Design

#### Cartridge Pre-Amps:

Exclusive solid state, instant-loading cartridge pre-amps drop into totally enclosed, weatherproof cartridge housing at point of signal interception. Models for 82-channel (VHF-UHF) antennas, VHF only, UHF only—plus a color spectrum filter. Custom-match the Super Colortron to any reception requirements.

#### Total Design

#### Impedance Correlators:

Exclusive impedance correlators (2 patents pending) automatically increase 75 ohm driven elements to 300 ohms to provide 100% signal transfer from antenna to set. Enables antenna to be 20% more compact!

### (B) Total Design

#### Vertical Resonant Reflectors:

Exclusive UHF vertical resonant reflectors achieve highest realizable gain on channels 14-83 because of exceptionally large vertical capture area. More UHF gain than any other 82-channel antenna design.

#### Total Design

#### Electro-Lens Director System:

Exclusive patented Electro-Lens system (U.S. Patent 2,700,105; Canada 511,984) absorbs entire signal and focuses it directly onto the driven elements to give Super Colortrons pinpoint directivity.

Circle 21 on reader's service card

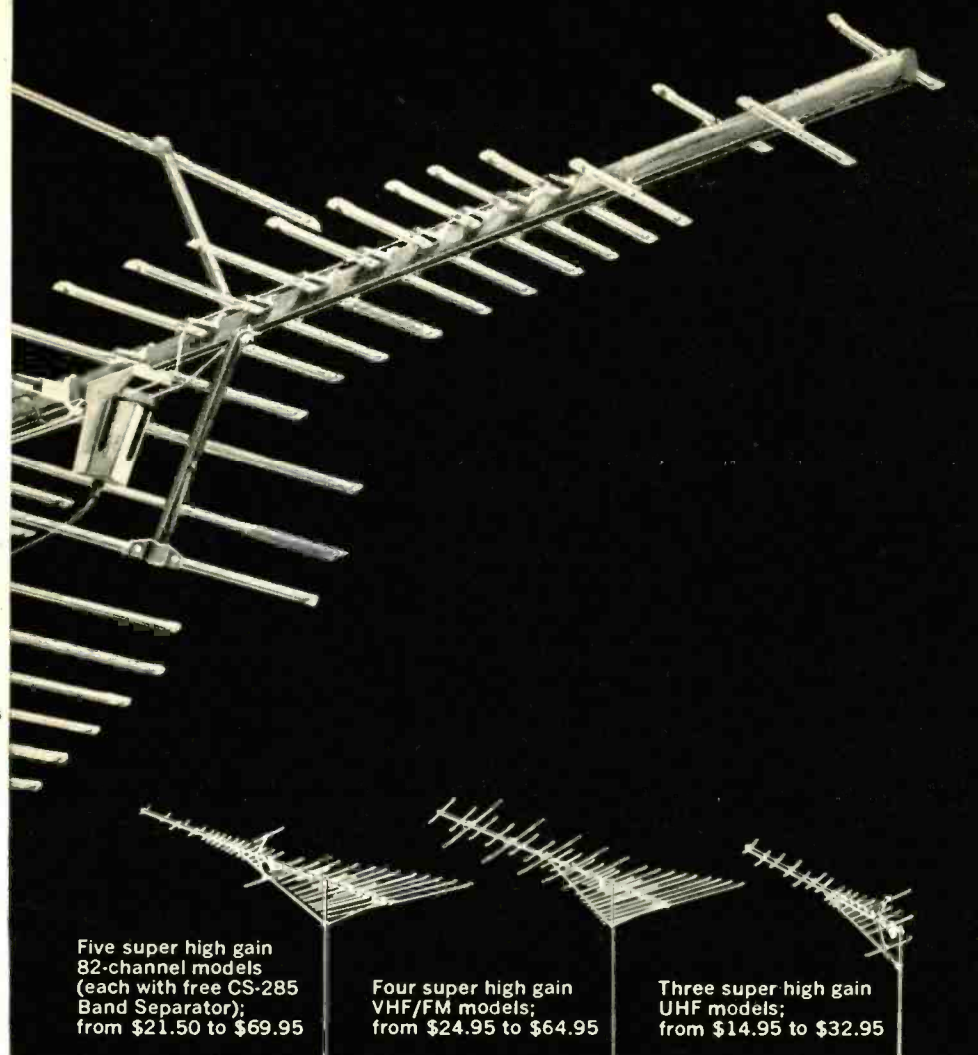

Five super high gain  
82-channel models  
(each with free CS-285  
Band Separator);  
from \$21.50 to \$69.95

Four super high gain  
VHF/FM models;  
from \$24.95 to \$64.95

Three super high gain  
UHF models;  
from \$14.95 to \$32.95

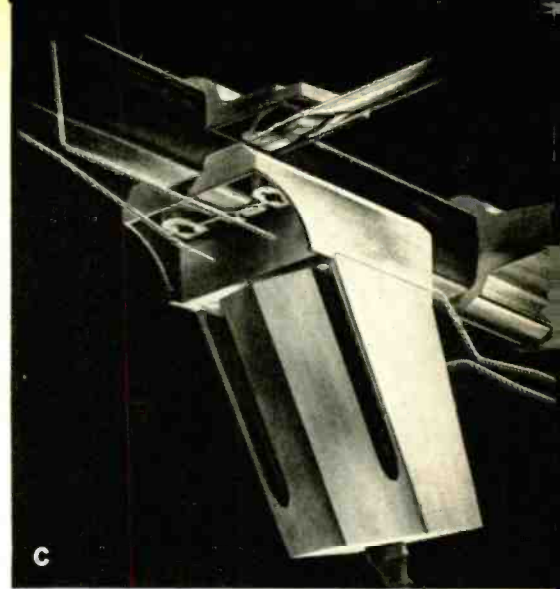

C

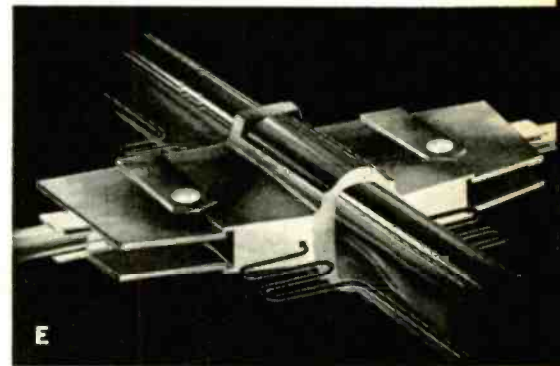

E

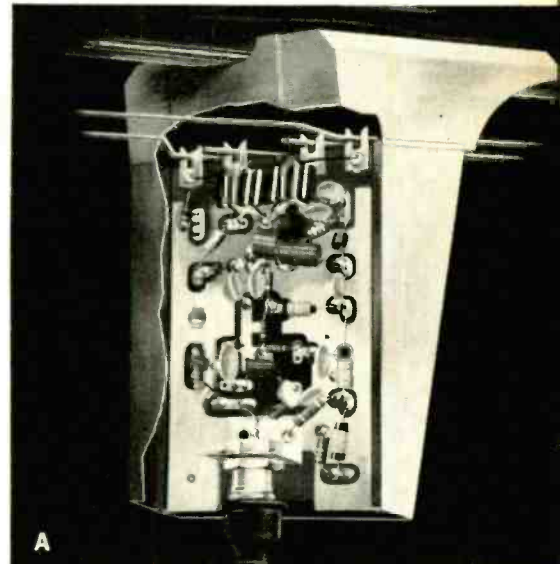

A

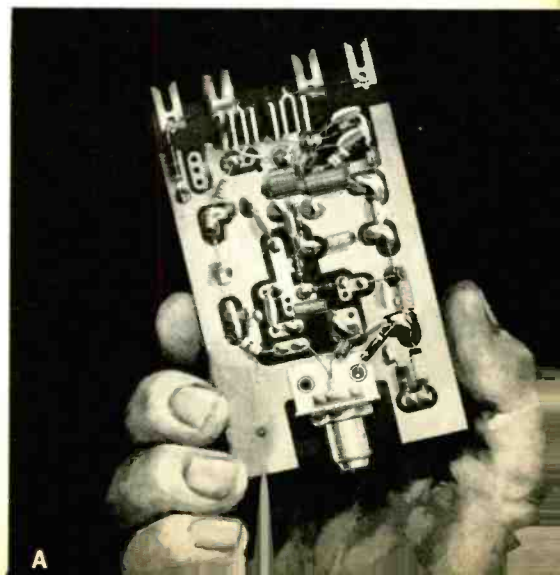

A

**Total Design FM Control Element:**

Exclusive FM element provides high gain on FM bands—and enables you to attenuate FM bands in areas where strong FM signals interfere with TV reception.

**(C) Total Design Cartridge Housing:**

Exclusive housing is an integral part of Super Colortron—built-in and permanent. Completely weatherproofed to protect solid state cartridge pre-amps and connections.

**(D) Total Design Ellipsoidal Boom:**

Exclusive boom is the first aluminum tubing shape engineered especially for antenna use. Proved far stronger than any other existing boom design.

**(E) Total Design Wrap-Around Insulators:**

Exclusive low loss dielectric insulators completely encapsulate and weatherproof elements and correlators at point of electrical contact. Hi-impact polystyrene. Provide perfect alignment of elements and eliminate sagging and loosening.

**Total Design High Tensile Aluminum Elements:**

Exclusive aluminum alloy has PSI rating of 38,000 as compared to 27,000 PSI for alloys used in other antennas. More than 49% stronger—and 29% more resistant to bend and wind distortion.

**Total Design Wrap-Around Mast Clamp:**

Exclusive mast clamp has 4 pair of locking jaws (not just 2) to automatically align antenna on mast and for greater strength and durability. Requires only one U bolt.

**Total Design Gold Anodizing:**

Exclusive Gold Anodizing is the only permanent gold finish used on any antenna—the only positive protection against corrosion and fading.

**Total Design Assembly:**

Exclusive construction makes the Super Colortron truly easy-to-install—unfolds in seconds—completely factory pre-assembled.



**Winegard**  
ANTENNA SYSTEMS

WINEGARD COMPANY, 3000 KIRKWOOD STREET, BURLINGTON, IOWA 52601

[www.americanradiohistory.com](http://www.americanradiohistory.com)

# WHY risk your reputation with "just-as-good" capacitors?

When you pay little or no attention to quality in tubular replacement capacitors, you leave yourself wide open for criticism of your work . . . you risk your reputation . . . you stand to lose customers. It just doesn't pay to take a chance on capacitors with unknown or debatable performance records when it's so easy to get guaranteed dependable tubulars from your Sprague distributor!

## There's no "maybe" with these 2 great SPRAGUE DIFILM® TUBULARS!

The ultimate in tubular capacitor construction. Dual dielectric . . . polyester film and special capacitor tissue . . . combines the best features of both. Impregnated with HCX®, an exclusive Sprague synthetic hydrocarbon material which fills every void in the paper, every pinhole in the plastic film *before it solidifies*, resulting in a rock-hard capacitor section . . . there's no oil to leak, no wax to drip. Designed for 105°C (220°F) operation without voltage derating.

### DIFILM® ORANGE DROP® Dipped Tubular Capacitors



A "must" for applications where only radial-lead capacitors will fit . . . the perfect replacement for dipped capacitors now used in many leading TV sets. Double-dipped in rugged epoxy resin for positive protection against extreme heat and humidity. No other dipped tubular capacitor can match Sprague Orange Drops!



### DIFILM® BLACK BEAUTY® Molded Tubular Capacitors

The world's most humidity-resistant molded capacitors. Tough, protective outer case of non-flammable molded phenolic . . . cannot be damaged in handling or installation. Black Beauty Capacitors will withstand the hottest temperatures to be found in any TV or radio set, even in the most humid climates.

For complete listings, get your copy of Catalog C-617 from your Sprague distributor, or write to Sprague Products Company, 81 Marshall Street, North Adams, Massachusetts.

**SPRAGUE®**  
THE MARK OF RELIABILITY

WORLD'S LARGEST MANUFACTURER OF CAPACITORS

Circle 22 on reader's service card

In the Shop . . . With Jack

continued from page 22

system, of 150 watts. Remember that the amplifier must be rated at 150 watts or better to handle this load.

You can wire a system like this with two-conductor No. 20 wire, and get plenty of volume at the furthest speaker. However high the voltage, or low the current, some loss in long lines should always be anticipated.

### Antenna grounding

*I'm wondering about my ground system. I've heard several versions of "what's right," and I'll like to be sure.—D.P., Orlando, Fla.*

The insurance underwriters' association, that ought to know, seems to feel that an 8-foot ground rod, driven all the way in, will provide a satisfactory ground connection. This is common practice in power systems, too.

You can get a very informative booklet from your insurance agent, called "TV and FM Antennas: Is Your Antenna Safely Installed?" If he doesn't have one, get it from the National Fire Protection Association, 60 Battery March St., Boston, Mass. 02110.

### Heater-string electrolytic

*I've got tube troubles in a Star-Lite TV-810 portable. Tube life seems to be short, and I get hum, distortion and other odd troubles intermittently. Line voltage normal—F.J., Norfolk, Va.*

Check your heater voltages in normal operation. This set has an unusual circuit (see diagram) using a nonpolarized electrolytic capacitor as a "dropping resistor" in the heater string! If this capacitor has developed high power factor (meaning a higher than normal leakage current) it could be running the heaters far too high and causing the short tube life.

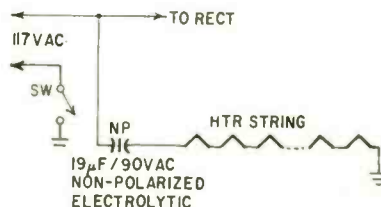

Hook an ac voltmeter across any heater, with the set off, and then turn it on. Watch the voltage; if it starts to go too high, try a new capacitor, or check the original very carefully for capacitance and power factor. **R-E**



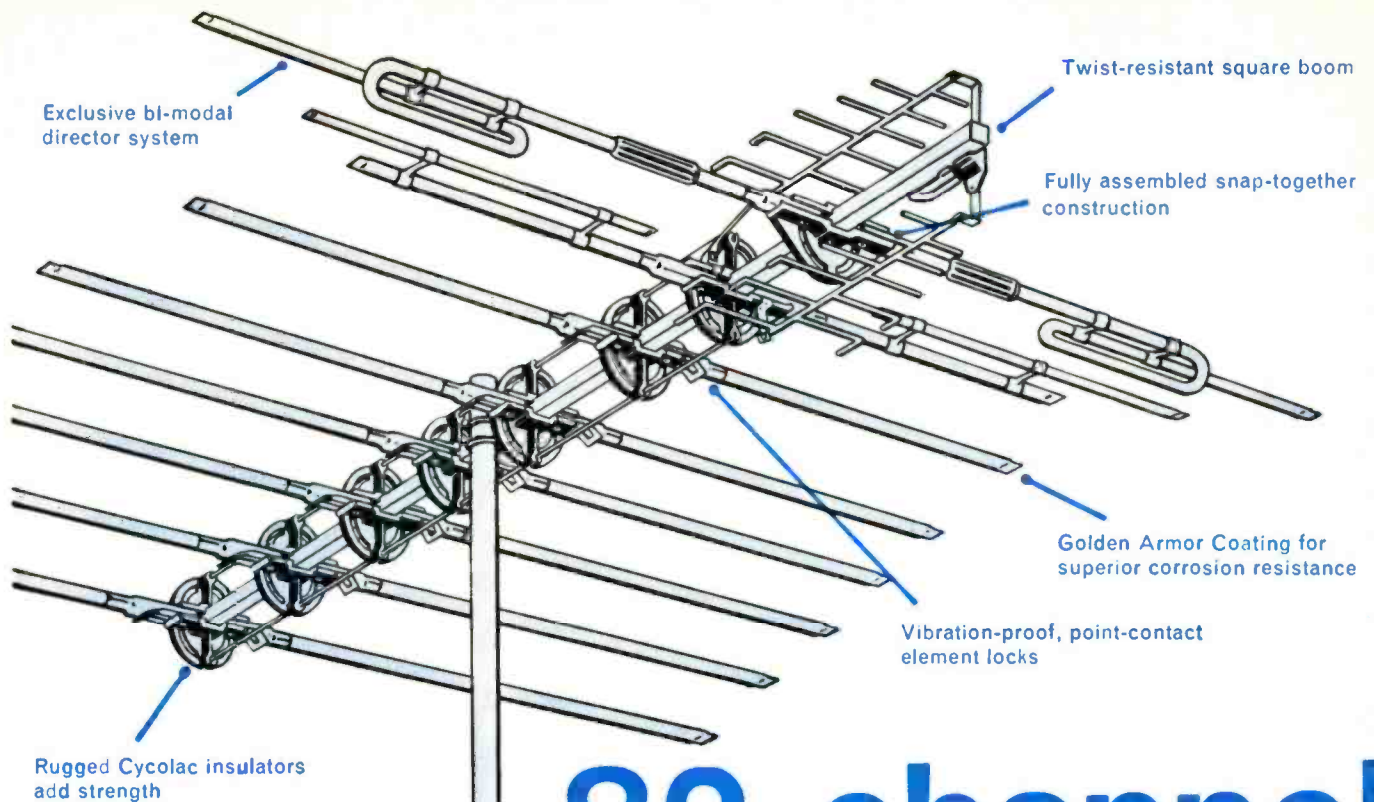

# 82-channel signal grabber

The Jerrold VUfinder® Antenna. The first 300-ohm UHF-VHF-FM antenna designed—from the ground up—for uncompromising color and black-and-white excellence across the entire TV spectrum. Models available for metropolitan to deepest fringe areas.

- Sharp directivity eliminates color ghosts
- Flat response ( $\approx 1$  db per channel) for optimum color fidelity
- Exclusive bi-modal director system for extra gain

VUfinders are easy to put together, can't possibly fall apart. The quality that's built in stays in. Quickly convertible to 75-ohm Color-axial performance. VUfinders come in 5 models. Each is supplied with a UHF/VHF frequency splitter. And the list prices range from \$17.95 to \$79.95. There's no better performance per dollar than this—anywhere.

For the most efficient 300-ohm signal grabber in Jerrold's Spectrum '67, see your Jerrold Distributor *today* about the Jerrold VUfinder antenna.

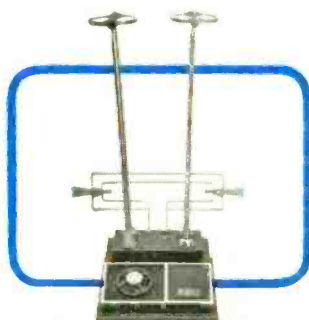

Indoor antennas



Home pre-amplifiers



Distribution equipment



*Focusing on one thing...  
better reception*

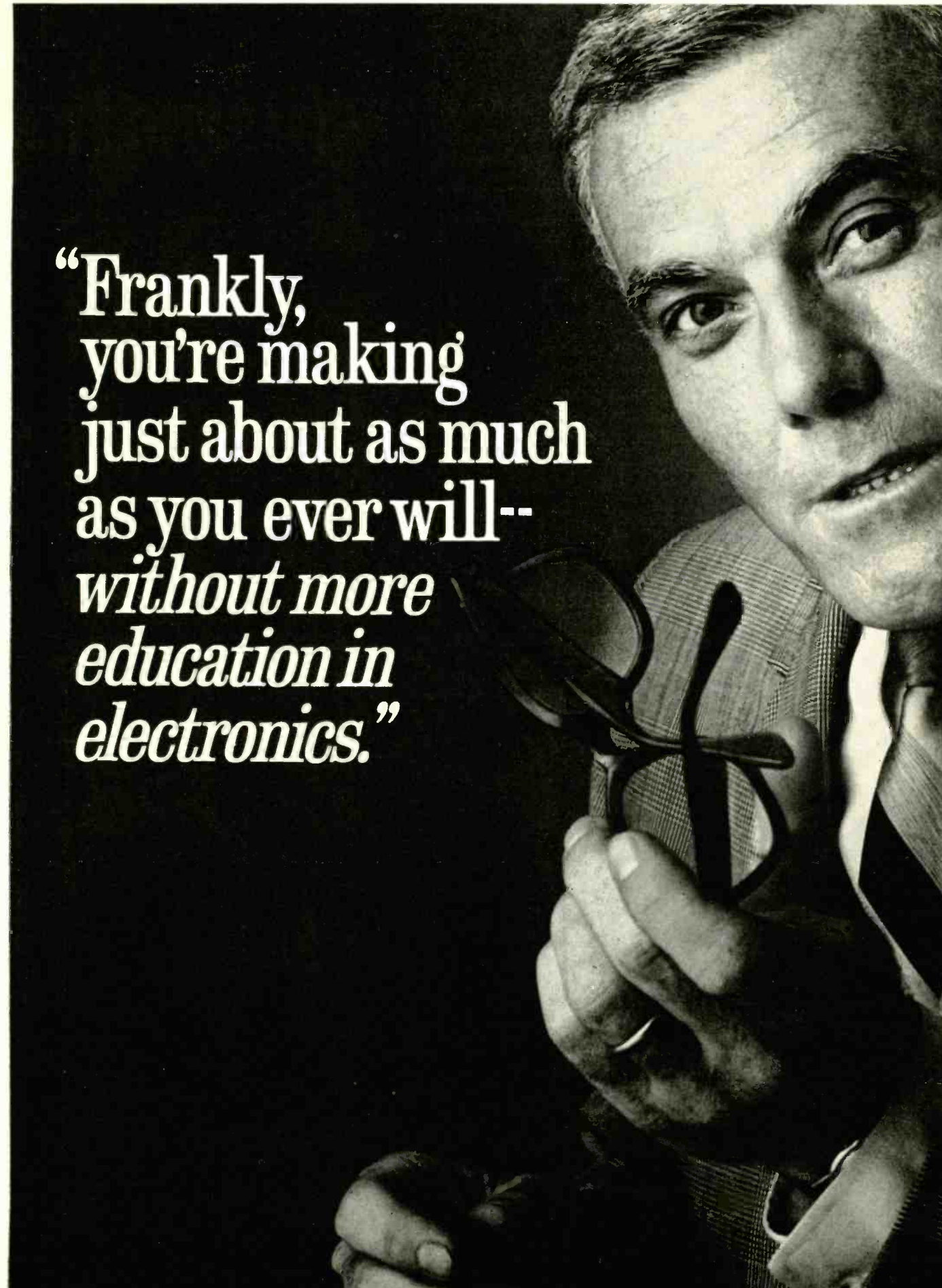

“Frankly,  
you’re making  
just about as much  
as you ever will--  
*without more  
education in  
electronics.*”

**Ask any man who really knows the electronics industry.**

Opportunities are few for men without advanced technical education. If you stay on that level, you'll never make much money. And you'll be among the first to go in a layoff.

But, if you supplement your experience with more education in electronics, you can become a specialist. You'll enjoy good income and excellent security. You won't have to worry about automation or advances in technology putting you out of a job.

How can you get the additional education you must have to protect your future—and the future of those who depend on you? Going back to school isn't easy for a man with a job and family obligations.

CREI Home Study Programs offer you a practical way to get more education without going back to school. You study at home, at your own pace, on your own schedule. And you study with the assurance that what you learn can be applied on the job immediately to make you worth more money to your employer.

You're eligible for a CREI Program if you work in electronics and have a high school education. Our FREE book gives complete information. Air-mail postpaid card for your copy. If card is detached, use coupon below or write: CREI, Dept. 1410E, 3224 Sixteenth Street, N.W., Washington, D.C. 20010.



**The Capitol Radio Engineering Institute**

A Division of McGraw-Hill, Inc.  
Dept. 1410E, 3224 Sixteenth Street, N.W.  
Washington, D.C. 20010

Please send me FREE book describing CREI Programs. I am employed in electronics and have a high school education.

NAME \_\_\_\_\_ AGE \_\_\_\_\_

ADDRESS \_\_\_\_\_

CITY \_\_\_\_\_ STATE \_\_\_\_\_ ZIP CODE \_\_\_\_\_

EMPLOYED BY \_\_\_\_\_

TYPE OF PRESENT WORK \_\_\_\_\_  G.I. BILL

- I am interested in  Electronic Engineering Technology
- Space Electronics  Nuclear Engineering Technology
- Industrial Electronics for Automation
- Computer Systems Technology

**APPROVED FOR TRAINING UNDER NEW G.I. BILL**





## CARTRIDGE TRACKING TESTS

*Quick and easy checks include channel separation, output and overall operation*

TO PERFORM PROPERLY A RECORD PLAYER MUST operate at correct speed without rumble, flutter and wow. Its pickup arm must operate smoothly without any drag and be able to support the cartridge at the proper angle and at the proper stylus pressure. The cartridge and the stylus must be able to track the record groove and respond to its high-speed excursions. Many of these requirements have yet to be fully met, but progress in the state of the art brings us ever closer to the ideal.

Besides having records with all of the sounds properly impressed on their surfaces and

the related hi-fi equipment to translate these impressions, it is necessary to have suitable test equipment and test procedures to permit identification of good and not-so-good operation. It is now possible, with use of commonplace test equipment and a test record, to check stereo cartridges quickly in a sophisticated manner. Procedures that had heretofore been normally relegated to the audio laboratory can now be duplicated in the field.

With these new tests, within a matter of minutes, you will be able to determine: the maximum velocity the cartridge will track, at the recommended tracking force; channel separation, and the overall operation of the cartridge.

The ability of a cartridge to track properly at a minimum force is very desirable; the wear on the record and the stylus is kept to a minimum. However, a stylus tracking at a force too light to maintain contact with the groove wall (mistracking) can cause permanent damage to the record. Therefore, the proper adjustment of the tracking force is very important to reduce mistracking and to obtain maximum stylus and record life.

The tests should be performed in the order stated. If the stylus is badly worn or damaged, it should be changed. Otherwise, the life of the test record will be drastically reduced. A mild amount of stylus wear will not cause damage.

Fig. 1. Knurled knob near pickup arm's pivot adjusts antiskate force. Counterweight at left is for lateral balance. Photo courtesy Sony Corp. of America.



®Shure Brothers Inc., 222 Hartrey Ave., Evanston, Ill.

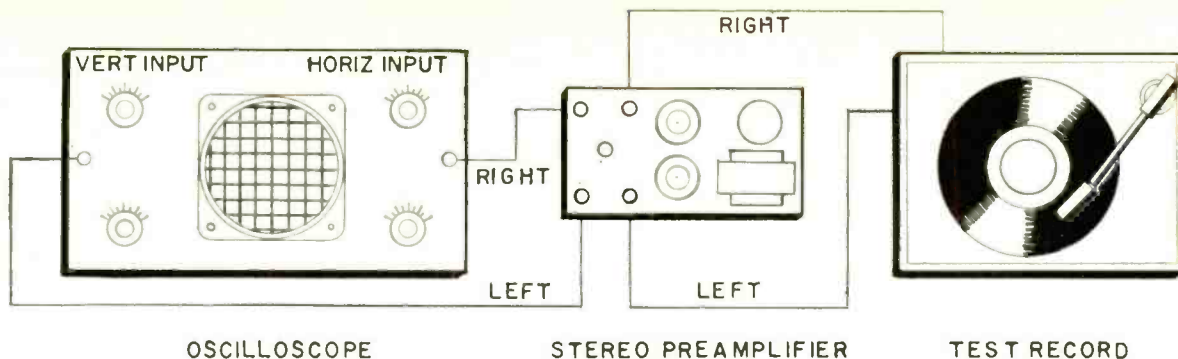

Fig. 2. Specially modulated grooves in a test record provide a quick check of the limits of cartridge tracking and the effects of skating and antiskating forces. Preamplifier inputs should be flat. Scope is conventional.

### CLEAN THE STYLUS

For a stylus to trace the groove accurately, the stylus must be clean. To clean it, use a camel's-hair brush (No. 2 size or smaller) dipped lightly in alcohol. The alcohol will remove any sludge deposits which may have coated the stylus tip. The brush bristles should be trimmed to a length no longer than  $\frac{1}{4}$ ". (Do not use alcohol when cleaning Ortofon cartridges, as permanent damage to the bearing can result.)

Always brush the stylus with a forward movement from the rear, or terminal end of the cartridge, to the front of the cartridge. Never brush or wipe the stylus from front to back or side to side.

### TURNTABLE SPEED

To check turntable speed, use a stroboscope disc, and follow the instructions that come with it.

### TRACKING FORCE

Adjust the pickup arm in accordance with the manufacturer's instructions.

Set the tracking force at the middle of the tracking-force range stated by the cartridge manufacturer. If the suggested range is 2 to 4 grams, set the tracking force at 3 grams.

Check the actual tracking force with a gauge. Lift the cartridge and arm from a non-moving record until the stylus just loses contact with the record groove. Hold the stylus gauge parallel to the turntable when making tracking-force measurements.

### ANTISKATING FORCE

Disregard the following instructions if the pickup arm has no antiskating compensation system. When the stylus is in contact with the record groove, a certain amount of friction is present. As the force on the stylus is increased, this friction is increased. This friction tends to pull the stylus assembly forward, out of the cartridge. Since the cartridge is held in place by the pickup arm and mounted at an angle, to reduce tracking-angle error, a resultant force occurs that tends to pull the pickup arm toward the center of the record. This

force (skating force) unbalances the action of the stylus in the groove.

By adding the proper amount of external force on the arm, to pull it away from the center, the two forces (skate and antiskate) cancel and the stylus exerts equal force on both sides of the record groove. The inward force is a fraction of the stylus/record-groove friction and any increase in stylus force increases the friction and hence the skating force.

Set the antiskating-force adjustment at zero for the first part of the test. The proper setting will be determined later during the tracking test. An antiskate mechanism and adjuster are shown in Fig. 1.

### EQUIPMENT SETUP

Hook up the equipment as shown in Fig. 2. Plug the left- and right-channel outputs from the record player into left and right channels of the preamplifier, respectively. Use microphone or auxiliary (flat) inputs on the preamplifier to enable you to perform the test without equalization. If the record player has a ground lead, connect it to the preamplifier. Connect the preamplifier's left-channel output to the vertical input of the scope, and the right-channel output to the scope's horizontal input. Set the scope's horizontal sweep control to external sweep, and the vertical and horizontal gain controls to obtain a trace spread across approximately four large divisions on the CRT.

Shure Brothers, Inc., through their distributors, offers a test kit which includes a stereo preamplifier, a test record, a professional stylus pressure gauge and an illustrated instruction manual. The test record will be available without the other items in the kit.

### CARTRIDGE-OUTPUT TEST

To test the right-channel output of the cartridge, select a band on the test record which has right-channel modulation only, at a nominal frequency of about 1000 Hz. You should get a horizontal trace as shown in Fig. 3. Left-channel output can be checked in a similar manner by selecting a band which has only left-channel modulation. If all is well, you should get a vertical trace as shown in Fig. 4. If the results are reversed, the

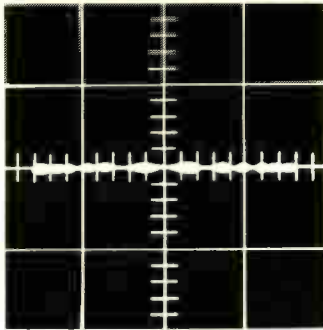

Fig. 3. Right-channel output shows up as horizontal sweep.

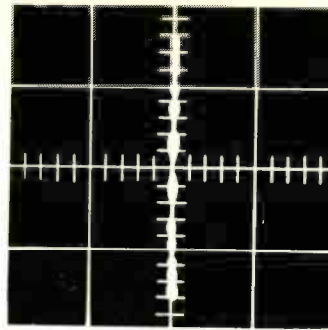

Fig. 4. Left-channel output shows up as vertical deflection.

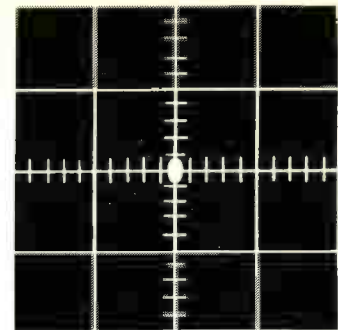

Fig. 5. Good left-channel output when right is modulated.

leads from the cartridge or from the preamplifier are reversed.

### CHANNEL-SEPARATION

Disconnect the right-channel lead going to the preamplifier and play the 1000-Hz left-channel-modulated band. Set the scope's vertical gain control for 20 minor divisions. Then, without touching the scope's vertical gain control, play the 1000-Hz right-channel band. If you have good separation, the trace will drop down to approximately two divisions as shown in Fig. 5.

A difference of 10 times is 20 dB channel separation. Any ratio greater than this is acceptable. The same check can be made at 10,000-Hz using respective left and right 10,000-Hz-modulated bands.

You can reverse the procedure to check the right channel by disconnecting the left-channel lead to the preamplifier and connecting the right-channel lead from the preamplifier to the scope's vertical input. In a good cartridge, test results should be about the same.

If there are two different readings, don't assume that the channel-separation figure is the average of the two readings. If anything, the poorer reading is the more significant one.

Replace the leads in their original position when this test is completed.

### TRACKING TESTS

Set the horizontal control on the scope to internal sweep. Play the 1000-Hz-modulated left channel and set the sweep rate for 2 cycles of dis-

play (500Hz). The waveform should look like Fig. 6. A distorted waveform such as shown in Fig. 7 indicates that the cartridge is mistracking. To check the right channel, switch the input leads to the preamplifier and play the 1000-Hz-modulate right-channel band.

Other-frequency, single-channel bands such as 10,000 Hz can be used in a similar manner. To observe 2 cycles of a 10,000-Hz signal on the scope, set the horizontal sweep rate to 5,000 Hz. Replace the leads to the preamplifier, in their original position, before proceeding to the next test.

### TRACKING TESTS—BOTH CHANNELS

The faster the stylus has to travel, the more difficult a time it will have. A stereo cartridge should be able to track at a minimum velocity of 14.7 cm/sec. This speed can be equated to only moderately loud passages on present-day stereo recordings. A cartridge should be able to track between 22.6 and 27.1 cm/sec. The waveform shown in Fig. 8 is obtained when the stereo cartridge is tracking properly.

Start the tracking tests on the lowest-velocity band on the test record. When proper tracking is observed on a low-velocity band, move on to the next most difficult band. Continue moving to the next most difficult band until mistracking occurs.

Once mistracking is observed, *do not* go on to the next band. Try to correct the mistracking in the following manner.

Right-channel mistracking distorts the

Fig. 6. Normal tracking waveform... single-channel output.

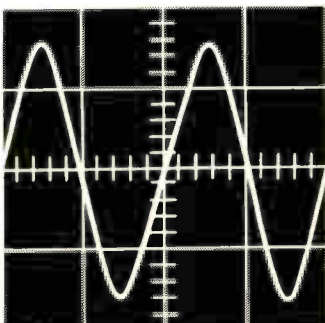

Fig. 7. Cartridge is mistracking. Same test as for Fig. 6.

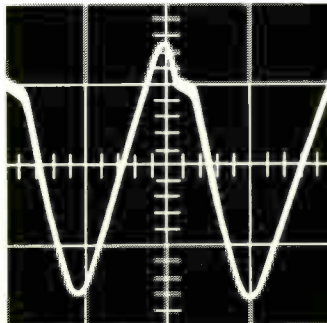
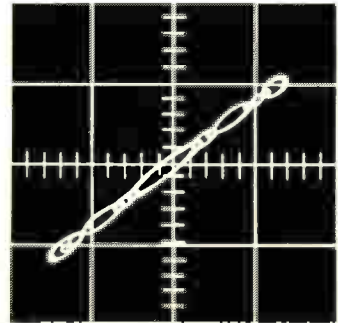

Fig. 8. Stereo cartridge tracking both channels normally.



# Hi-Fi 1968

Cartridges  
Speakers  
Components  
Systems  
Tape Recorders

## 1967 New York High Fidelity Music Show

Sept. 21—3:30 PM—10:00 PM  
Sept. 22—3:30 PM—10:00 PM  
Sept. 23—Noon—10:00 PM  
Sept. 24—Noon—6:00 PM

## 1967 Los Angeles High Fidelity Music Show

Nov. 2—4:00 PM—10:30 PM  
Nov. 3—4:00 PM—10:30 PM  
Nov. 4—Noon—10:30 PM  
Nov. 5—Noon—6:00 PM

Hear a smorgasbord of stereo sound at the Hi-Fi shows this year at the Statler Hilton Hotel, 7th Ave., at 32nd St., in New York, or at the Ambassador Hotel, 3400 N. Wil-

shire Blvd., in Los Angeles. You will find the sound is great and the variety of goodies most tempting. What you see here is just a sampler.

For the man who has everything: Harmon-Kardon's stereo lounge, with speakers built into the sides of the "egg."

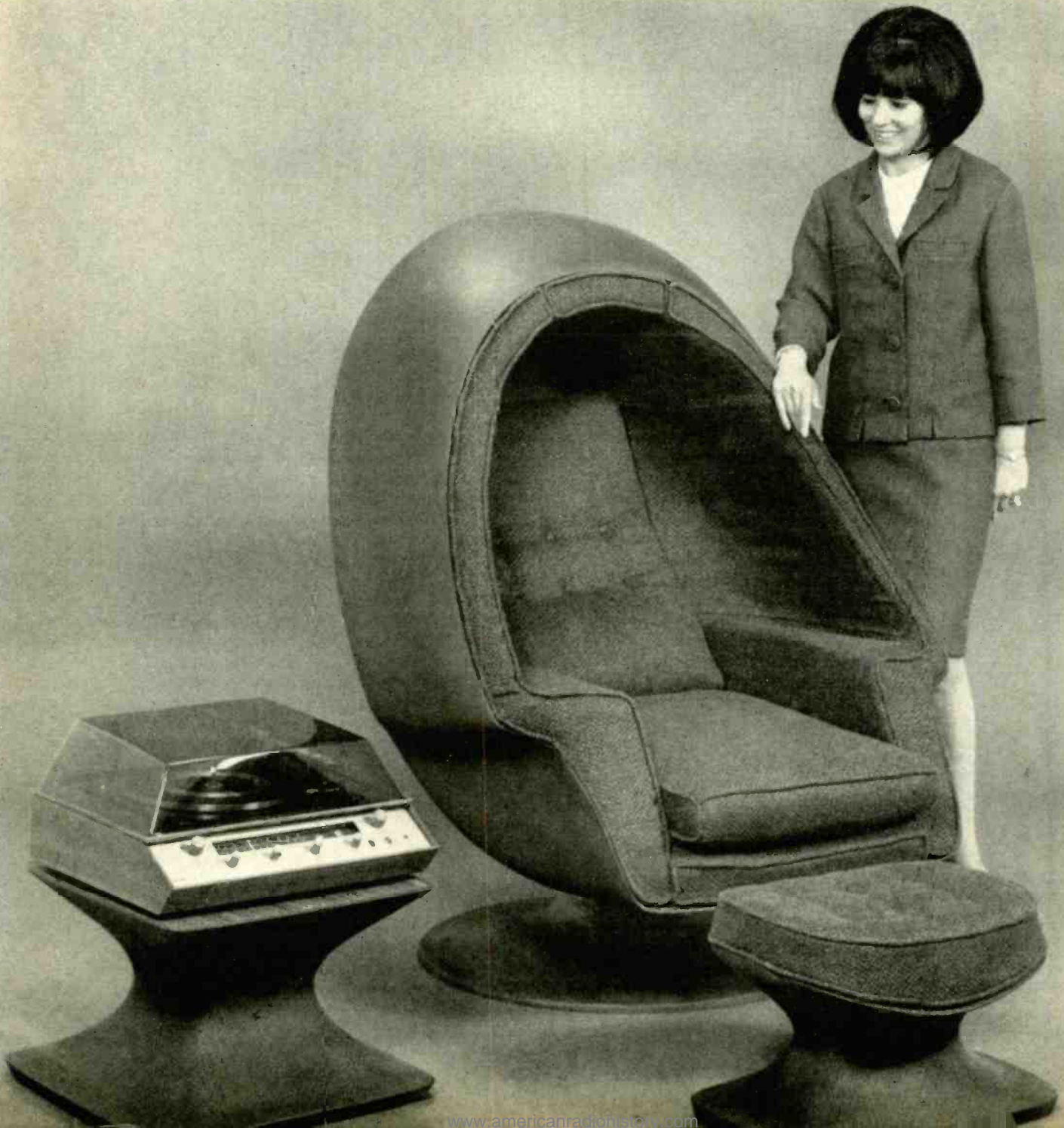

# COMPONENTS and SYSTEMS



Acoustic  
Research  
Amplifier

Acoustech  
VIII Tuner  
(kit)



Allied  
399 AM/FM  
Stereo  
Receiver

Altec  
711B  
Receiver

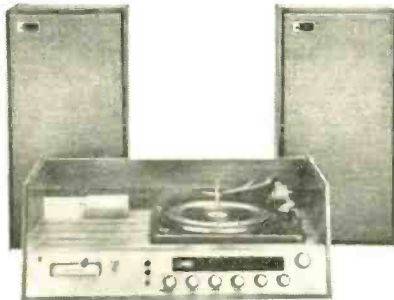

Bogen  
MSC-1  
Compact  
System

Dynaco  
PAT-4  
Preamp



EICO  
3570  
Receiver

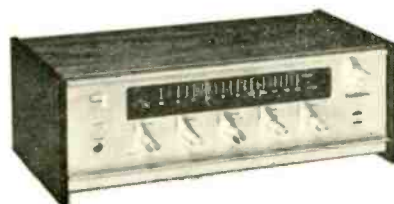

Electro-Voice  
EV1180  
Receiver

Empire  
Troubadour  
398



Fisher  
110 Compact  
System

Garrard  
Synchro-Lab  
75 Automatic  
Turntable



IF YOU DON'T FIND ALL THE components you need to make a stereo system to suit your needs at the hi-fi shows this year, it won't be the manufacturers' fault. Good home sound reproduction is no longer just a plaything for the idle rich.

There was a time when you were cautioned against buying a receiver (tuner, preamp and amplifier with all controls, on a single chassis). The argument against it was that quality couldn't possibly be as good since everything that would normally take three chassis and cabinets had to be crammed into one. People talked about heat, higher hum level, skimpy output transformers, etc.

Ten years ago, these arguments carried

some weight, but now they don't. In a receiver of good design and manufacture, these problems do not exist. Today's hi-fi receiver is definitely not a glorified "radio." The higher-priced units offer all the performance and the switching flexibility of a separate tuner-preamplifier-amplifier combination. This advance is due partly to transistors, and partly to the fact that manufacturers awakened to the market demands for a complete, integrated receiver with top-quality performance.

Then, why are manufacturers still turning out separate tuners, preamplifiers and amplifiers? One reason is simply that people still want them; they want to select individual components.



# Hi-Fi 1968



**G-E  
P960  
System**



**Schober  
TR-2 Basic  
Amplifier**

**Harman-  
Kardon  
SC2520  
Compact  
System (with  
cartridge  
tape unit)**



**Scott  
2502  
Compact  
System**

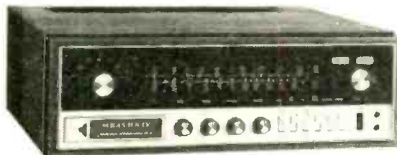

**Heathkit  
AR-15  
Receiver (kit)**



**Sony  
Components**

**Kenwood  
TKS-40  
System**



**Lafayette  
RK-580  
System (with  
cartridge  
tape unit)**



**Sherwood  
S-7600  
AM/FM  
Stereo  
Receiver**

**Marantz  
18 Receiver**



**Thorens  
TD-150-AB  
Turntable**



Not so long ago, there was a pretty clear difference between "hi-fi" (component setups) and "record players" (packaged units). Now the distinction is a bit obscure. The blurring of the definitions occurred in two ways. One way was pretty shoddy: some manufacturers of packaged phonos started describing their low-priced door-busters as "hi-fi." Soon you didn't have a record player, or a Victrola, or a phonograph, but always a "hi-fi," even if it had a single 50L6 vacuum tube and a 4-inch speaker. Some had twin 4-inch speakers.

The other way was much more sophisticated and meritorious. Manufacturers of genuinely good equipment began making smaller speakers

and amplifiers (but still quite good ones), and putting the amplifier in the same box with the turntable, and so on. Eventually this kind of product became a style all its own, and by now most major component manufacturers are making "compacts." Don't let anyone steer you away from them till you've heard them. The best are in a class with fine component hi-fi systems. For people who shy away from shopping for a whole system of separate components and hooking them together, or for people with little space, the "compact" systems are an ideal way of getting fine sound into the home. And that's what hi-fi is all about.

*(Cartridges and speakers →)*



RCA pickup arm with built-in IC preamp

# CARTRIDGES

PICKUPS HAVE ALWAYS BEEN among the weak points in high-quality sound reproduction. Tracing accurately the rapid wiggles in a groove about a thousandth of an inch wide is difficult.

The problem is often oversimplified into one of compliance and stylus tip size. At least that's about all that has filtered down to the public via ads and reports. Most engineers, however, have recognized for many years that tracing a record groove involves complex interrelated factors, of which compliance and tip size are only parts. Other factors are the elasticity of the record material, the dynamic mass of all other moving parts in the cartridge, the mass of the pickup arm, and so on.

Some engineers tackled the problem with an analog computer, and there is good reason to believe that the manufacturers will start to make the public aware that the critical matter is how well the cartridge plays the record, and not just report out characteristics that make it tough to separate good from mediocre cartridges.

There's still a great diversity in cartridge designs, even among those that can be called "magnetic."

We can report striking progress in the manufacture of low-cost, high-quality ceramic cartridges, a result of simplified mechanical design and automated assembly. Two ceramic elements, which generate voltage when twisted (piezoelectric effect), are arranged in the conventional 90° angle for stereo cartridges. The forward ends of both elements are coupled to the stylus through a semi-flexible yoke; the back ends are clamped quite rigidly.

Ceramic cartridges are becoming quite respectable—many of them can compete with magnetic cartridges, and they offer certain advantages, such as complete insensitivity to electromagnetic pickup of ac hum fields, and high output voltage. Their response normally matches the RIAA curve only when they work into loads of several megohms. A few are designed to have output voltages and frequency characteristics suitable for connection to magnetic-phone inputs.

A very different kind of cartridge, neither piezoelectric nor magnetic, are the solid state types. Instead of generating a voltage, its resistance varies with stylus motion and modulates an external dc voltage, furnished by a power supply that comes with the cartridge.

The principle isn't new—it's basically a strain gage—but the application of the principle is ingenious. The strain-gage elements are tiny highly doped silicon fibers. There are two of them, mounted somewhat like the ceramic elements.

And then there's something that was bound to happen sooner or later: RCA has announced that it is using integrated-circuit preamps built right into the pickup-arm head, next to the pickup. Now if we can up the power of the IC a little, and find a very small speaker. . . .



Empire 999VE

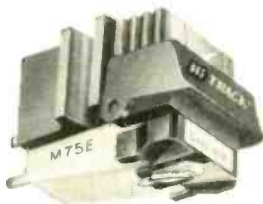

Shure M75E "Hi Track"



Euphonics "Miniconic"

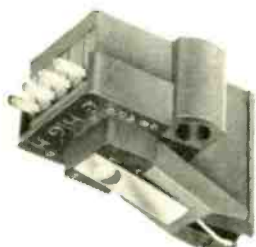

Grado Model B



Ortofon SL-15



Sonotone Velocitone Mark V

Only in pickups do we find such a variety of physical principles among the various makes for converting groove modulation into electronic signals. In the Empire and Shure cartridges magnetic flux is varied with stylus motion. The Euphonics, Grado and Sonotone are strain-gauge types . . . a change in pressure changes resistance. Ortofon uses moving coils in a field and works like a generator.

# SPEAKERS

## Hi-Fi 1968

THE OTHER END OF THE SOUND REPRODUCING chain is no less troublesome. Speakers, like pickups, have to convert energy from one form into another, only in reverse order. So far no one has found anything that will beat the many variations of the "electric motor" speaker—cone or diaphragm driven by a coil moving in a magnetic field. Not at a price we can afford, anyway. No news at this writing of any full-range electrostatics.

One thing you might look for when you visit the hi-fi show this fall: is there a trend back toward bigger speakers? This is not to say we suspect little speakers will disappear; just a shift in emphasis, like the unstable hemlines on ladies skirts, which get higher and lower from year to year.

1967 has brought in its crop of speakers, and there are a lot of good ones around. There weren't any radical technological advances. A great many are loosely called "acoustic suspension," which may mean anything from a speaker in a closed box to a meticulously engineered system with exceptionally smooth response, low distortion—and low efficiency. This low-efficiency thing is often used like a dirty word. It is a minor drawback, if it's a drawback at all.

The word "efficiency" is much misused; in the context of speakers, as in all machinery, it is simply the ratio of output power to input power, often expressed as a percentage. So to say that a speaker is inefficient is not to knock its sound-reproducing quality, but only to say that it eats a lot of electrical power from the amplifier to produce acoustical power. Some of the most marvelous-sounding speakers have efficiencies on the order of 1%. All that means is that your amplifier should be able to put out at least 25 "clean" watts per channel.

The resonant-box speakers, like the classic bass reflex and the ducted-port version, are, on the whole, a good deal more efficient, and so will produce a given loudness with less amplifier power.

No one principle of speaker enclosure design is better, necessarily, than any other. A particular manufacturer usually sticks with one or two types. The reasons are often obscure and the debates therefore hot. Buy what you like to listen to, not what someone tells you is good "because it's a bass reflex."

The E-V and Wharfedale speakers are varieties of acoustic suspension systems. The University is a resonant box, the Empire uses a hyperbolic horn. The JBL system uses a passive-cone. The Jensen is a column-type system with a wedge-shaped directivity. The Hartley speaker is a vented infinite baffle.



Jensen  
HFC-84



University  
Laredo



Hartley MK IV



JBL Caprice

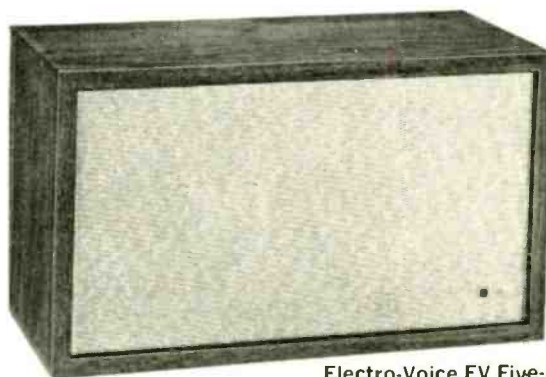

Electro-Voice EV Five-A

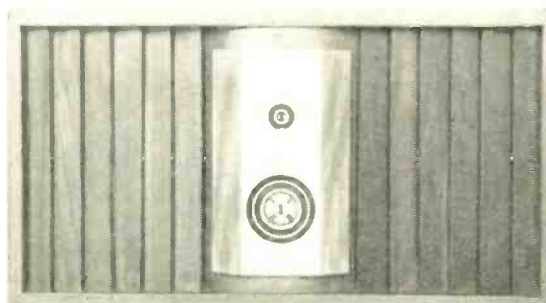

Empire 8400



Wharfedale W60D

# Hi-Fi 1968

## TAPE RECORDERS



Ampex Micro 85 cassette system

Newell  
cartridge-  
less tape  
changer



Norelco  
radio-and-  
cartridge-  
tape-player

Wollensak  
3500 reel-  
to-reel  
(left); 4200  
cartridge



Allied  
1040



Panasonic  
RS-766US



Sony 230-CPW

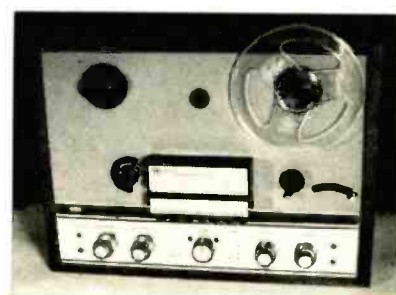

Heathkit/  
Magnecord  
AD-16

THERE'S A LOT TO BE SAID FOR TAPE. Everybody likes the fact that it can be erased and reused indefinitely until it wears out physically, that it can be spliced and edited, that several tracks can be recorded on a single strip with very little crosstalk, and so on.

Cartridges and the specialized machinery devised for their handling eliminate some of the problems of handling tape and make it almost as convenient as a disc record and a record player. But while the cartridge jobs solve some problems, they also remove some of the advantages tape has over discs.

For the person seriously interested in music, there is also the problem (temporary, we hope) that there is nowhere near the variety of recorded material there is on discs.

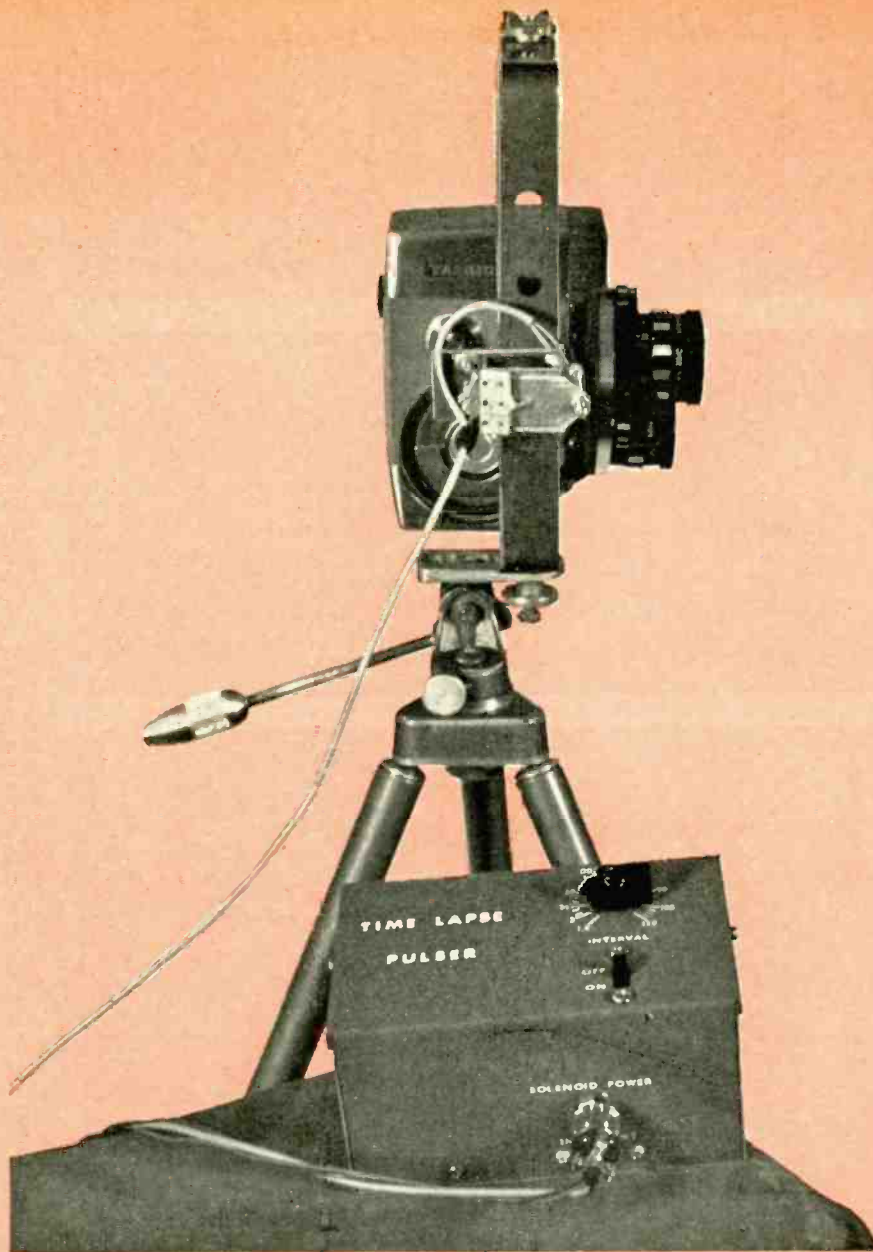

## BUILD — HOME MOVIES TIME-COMPRESSION MACHINE

Useful project for amateur movie makers can make you a pro at time-lapse photography By BRUCE E. JOHNSON

**T**ime-compression machine, or "Time-Lapse Pulser," take your choice . . . it triggers a movie-camera shutter to fire a single frame at a time at preset, precisely timed intervals. It will add greater versatility to your home-movie camera and create some startling photographic effects.

Time-lapse photography is the opposite of slow-motion pictures. It is a process of accelerating movement on the screen, without "eating" up more than a normal amount of film. With time-compression techniques, several months of activity can be made into a complete showing lasting no more than a few minutes—all in continuous motion. If you expose a frame every 5 seconds, the motion on the screen will be 80 times faster than normal; 1 frame every minute would speed the motion up almost 1000 times. Any desired time interval can be selected. The growth of a flower from seed

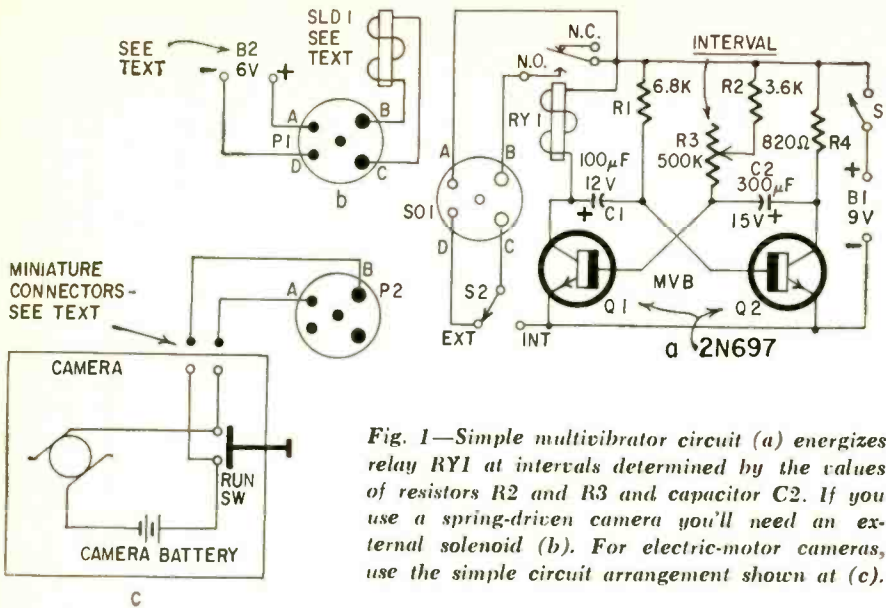

Fig. 1—Simple multivibrator circuit (a) energizes relay RY1 at intervals determined by the values of resistors R2 and R3 and capacitor C2. If you use a spring-driven camera you'll need an external solenoid (b). For electric-motor cameras, use the simple circuit arrangement shown at (c).

- Parts List**
- B1—9-volt battery, (NEDA 1603) two in parallel
  - B2—See text
  - C1—100- $\mu$ F, 12-volt electrolytic capacitor
  - C2—300- $\mu$ F, 15-volt electrolytic capacitor
  - P1, P2—Miniature 4- or 5-terminal male connector to match SO1 (Amphenol 126-217 or equivalent)
  - Q1, Q2—2N697 or similar
  - R1—6800-ohm,  $\frac{1}{2}$ -watt resistor
  - R2—3600-ohm,  $\frac{1}{2}$ -watt resistor
  - R3—500,000-ohm potentiometer, linear taper, (Centralab F1-500K or equivalent)
  - R4—820-ohm,  $\frac{1}{2}$ -watt resistor
  - RY1—6-volt, 335-ohm s.p.s.t. relay, (Potter & Brumfield RS5D or equivalent)
  - SO1—Miniature 4- or 5-terminal female chassis connector (Amphenol 126-218 or equivalent)
  - SLD1—Solenoid—made from modified Guardian series 200 relay coil and contact assemblies. Coil 6Vdc, 24 ohms; switch assembly s.p.d.t. See text.
  - 1-3" x 4" x 6" cabinet
  - Misc—Hardware, circuit board, battery connectors, etc.

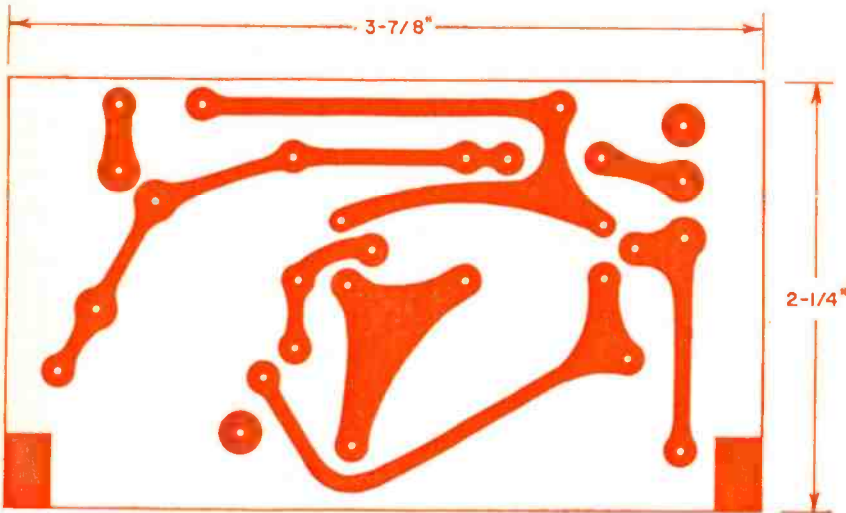

Fig. 2—You can use this actual-size drawing to make your own printed-circuit board.

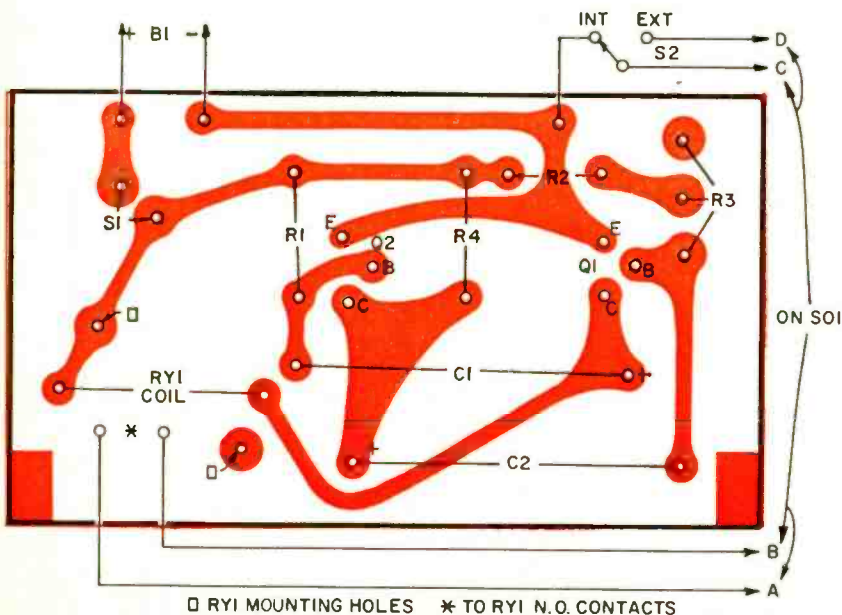

Fig. 3—Foil side of PC board showing location of components. PC board is optional.

to blossom, the flow of a river, the movement of boats, the passing of highway traffic, can be greatly accelerated, giving a humorous effect. The falling of autumn leaves or winter snow that took hours to occur can be reduced to a few minutes of film.

Before you undertake this simple, inexpensive project, make sure your camera has single-frame exposure or can be modified for it. The cost of the Pulser is approximately \$10-\$15, and the unit is completely portable. Batteries have long life as the device is transistor-operated and has low current drain. The Pulser has a stable time interval from 1.5 to 120 seconds (which can be extended if you desire).

### Theory

As Fig. 1 shows, the Pulser uses a conventional free-running multivibrator (or flip-flop) with one exception: half the MVB (C2, R2 and R3) has a *variable* time constant from 0.5 to 120 seconds, while the other half of the MVB has a *fixed* time constant of 1 second. Relay RY1 acts as the load for Q1 and when energized (during the 1-second pulse) closes the N.O. set of contacts. The interval between pulses can be extended by increasing the value of C2.

A solenoid is used to trip the shutter release on those cameras that utilize a spring-drive motor. The contacts of RY1 are used as an external switch on cameras having a battery-operated drive motor. The solenoid and S2 are not required if the Pulser is used with an electric-drive camera.

### Construction

Building the Pulser is simple—nothing is critical. All components, with the exception of the batteries and S2, and the solenoid (if used), are mounted on a printed-circuit board

(Fig. 2). If you don't wish to make a PC board, use a perforated phenolic board. The case is a 3" x 4" x 6" metal box. Mount all components, with the exception of R3 and S1, on the component side of the circuit board as shown in Figs. 3 and 4.

The relay is held in place with two 4-40 x 1/4" machine screws. Its coil is connected to the board by soldering a short piece of bare wire between each solder lug on the coil and the circuit foil. Use heat sinks when soldering Q1 and Q2, to avoid heat damage.

Next, mount R3 and S1 on the foil side of the board. R3 is mounted by bending the three solder lugs at a 90° angle and soldering the lugs to the foil. S1 is oriented level with R3 and then soldered in place. Refer to Fig. 5. Solder the necessary wires to the circuit board for connection between the battery connectors, S2 and the solenoid. The circuit board is held in place by S1 and R3. S1 is secured with two 8 x 1/4" sheet-metal screws, and R3 with its mounting nut.

Now refer to Fig. 6 for dimensions of holes and cutouts in the case. Solder leads to the battery connectors, S2 and the solenoid. I used a five-pin connector (one pin not used) to connect the solenoid and external battery leads to the timing circuit, although the leads may be brought out through a rubber grommet.

Install the batteries (B1) and attach the battery connectors. The two batteries take up half the space in the box and fit snug. However, you may wish to secure the batteries with a bracket as shown in the photos.

If your camera uses a spring drive, connect the solenoid as in Fig. 1-b. You can use any type of solenoid provided it has sufficient torque to trip the shutter release and if it can be mounted on or near the shutter release. If other than a 6- to 9-volt solenoid is used, you'll have to furnish external power from a suitable battery.

As a solenoid, I used a modified 6-volt 24-ohm relay (Guardian series 200). As you'll see in Figs. 7 and 8, I removed the contacts from the contact assembly and installed an extender arm (Fig. 7-a). The extension was held to the existing relay armature with a 6-32 x 1/4" machine screw through the existing hole. Mechanical linkage to the shutter release was made by joining a 2 1/2" 6-40 machine screw and 1 1/2" piece of 1/8" brass rod (tapered at one end) with a piece of nylon tubing (Fig. 7-b). The solenoid assembly was mounted on the bracket of a light bar.

I used this solenoid on a Yashica model 8EIII movie camera. Other types of cameras may require a different linkage to the shutter release, but you should not have much difficulty

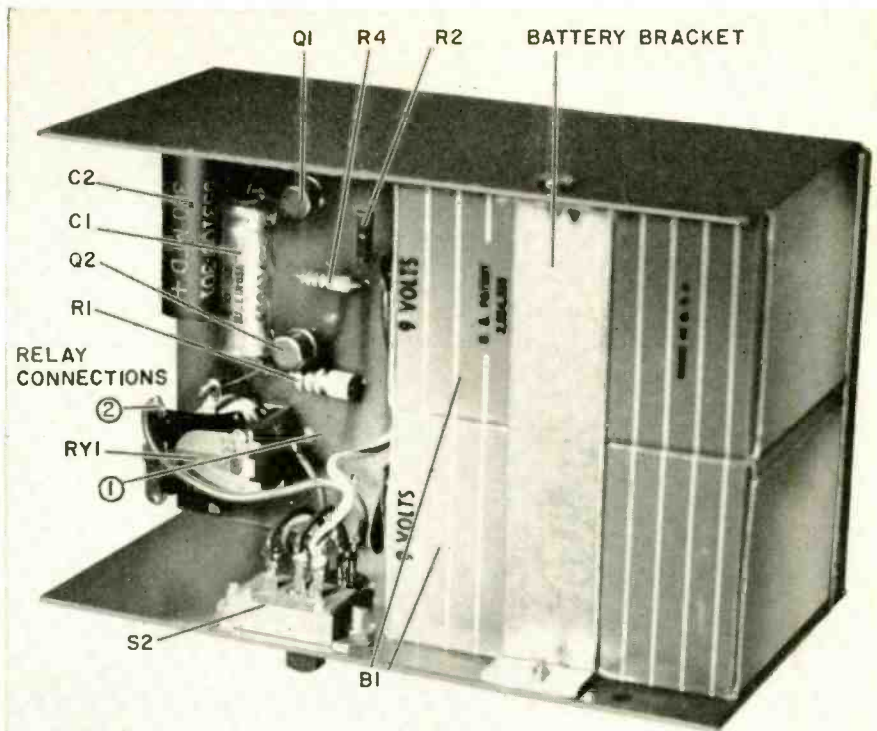

Fig. 4—Batteries fit snugly yet there's plenty of room for the other components.

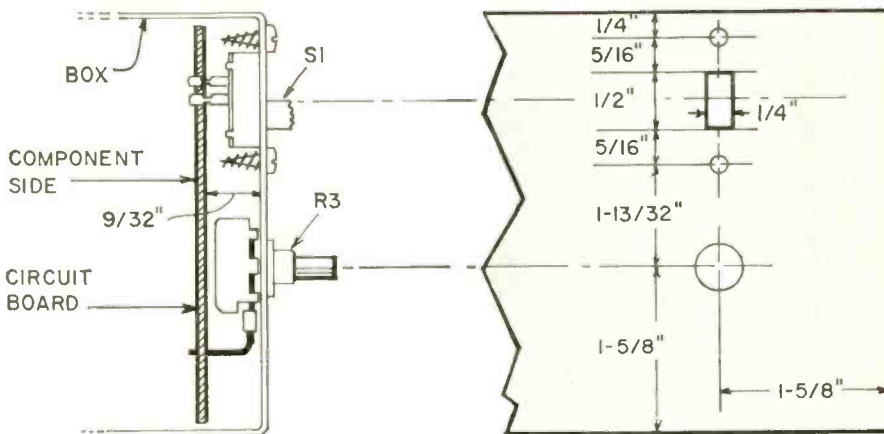

Fig. 5—Circuit board is held in place on the front panel by controls S1 and R3.

Fig. 6—Be accurate in locating the hole, to match PC board mounted S1 and R3.

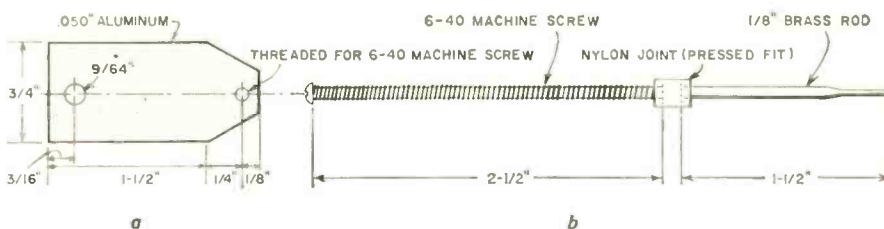

Fig. 7—Modify the relay by making up an extension arm (a) to support trigger arm (b). Setup is used on spring-driven cameras set to shoot single-frame exposures.

devising one. Cameras that have an electric drive will have to be modified by installing a miniature connector at a convenient point on the camera and wiring it across the run switch. When connected to the Pulsar, RY1 is an external camera switch (Fig. 1-c).

### Calibration

Set R3 (INTERVAL) fully clockwise and time the interval from the start of a single 1-second pulse to the start of the next pulse. Mark this point (num-

*continued on page 90*

Battery-powered and portable, it measures from below 0.006 volt up to 300 volts in 7 convenient ranges.



By JACK JAQUES

HEP TECHNICAL MANAGER  
MOTOROLA  
SEMICONDUCTOR PRODUCTS

## BUILD 22 MEGOHM FET DC VOLTMETER

UNIQUE, FIELD-EFFECT TRANSISTOR (FET) input and control circuits make it possible to construct a solid-state dc voltmeter (FET-VM) that has features seldom available in inexpensive test equipment. You can use it to measure voltage in high-impedance circuits and to discern small differences in potential across low-voltage transistor circuits. Input impedance is 22 megohms (twice that

of most vtvm's) on all ranges. Full-scale deflection can be obtained for 0.3, 1, 3, 10, 30, 100 and 300 volts.

Because of the high input impedance on the low-voltage range, you can use the FET-VM on agc circuits and oscillator circuits without loading them and upsetting their operation. In this regard the FET-VM works like a vtvm but, unlike most vtvm's, it is completely portable and not "tied" to a

117-volt ac power line.

Accuracy and linearity of meter readings are excellent. Also, each range can be individually adjusted to obtain correct calibration.

### Circuit theory

Differential amplifier Q2 and Q3 (Fig. 1) develops a "useful" output voltage—measured between the emit-

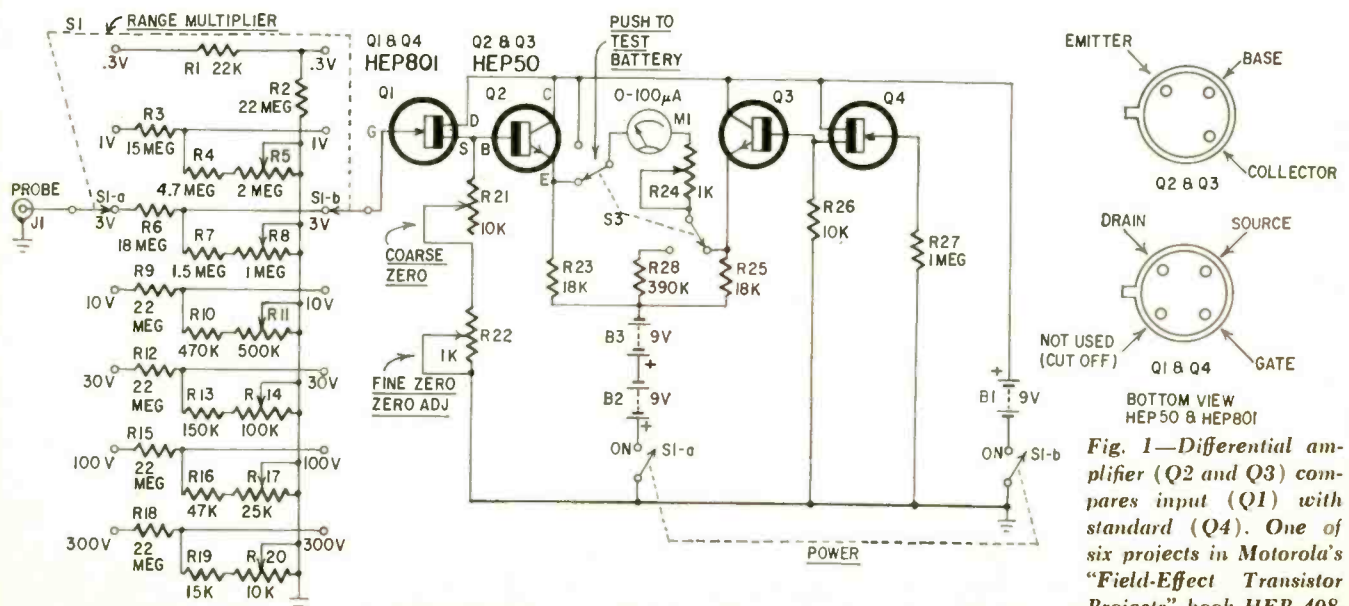

BOTTOM VIEW  
HEP50 & HEP801

Fig. 1—Differential amplifier (Q2 and Q3) compares input (Q1) with standard (Q4). One of six projects in Motorola's "Field-Effect Transistor Projects" book HEP 408.



ters—when the current through Q2 exceeds that through Q3. Transistor Q3's base bias and emitter current (through R25) are held constant by the fixed operation of FET Q4. Transistor Q2's base voltage and emitter current (through R23) vary with the test voltage to be measured. The test voltage is applied to Q1's gate through one of the voltage dividers selected by S2, such as R1 and R2 on the 0.3-volt range. Current flows through the meter when the voltage drop across R23 exceeds the drop across R25. The higher the voltage being tested, the higher the meter reading.

Resistors R21 and R22, when properly adjusted, control the current through FET Q1 to make it equal to the current through FET Q4, when no test voltage is applied to J1. Transistor circuits Q2 and Q3 are equal with respect to bias and emitter currents and set up an equal voltage drop across R23 and R25. No current can flow through the meter under these conditions and the reading is zero.

### Construction

Use of readily available perforated board having holes  $\frac{1}{4}$ " on center

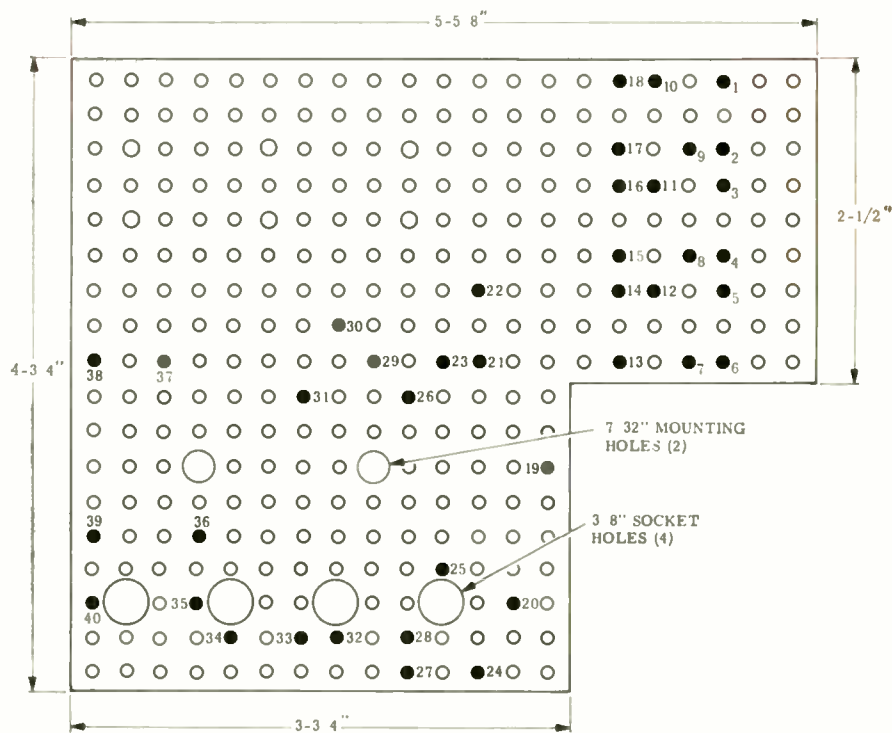

Fig. 2—Perforated board holes are  $\frac{1}{4}$ " on centers. The numbers represent terminals.

simplifies wiring and assembly. While the bulk of the work is not critical, it should be clean, especially in the vicinity of the FET gate leads. Cut the board to size and shape as shown in Fig. 2. If you prefer to wire the transistors directly to the board, don't drill the  $\frac{3}{8}$ " holes.

The two  $\frac{7}{32}$ " mounting holes must line up with your meter when the me-

ter and the board are mounted in the case. It is best to mount the meter in the case first, then position the board in place to find the exact location of these two holes. The numbers are not actually on the board, but are shown here to help you duplicate the wiring of the original model. Insert a push-in terminal in each of the numbered

*continued on page 68*

### PARTS LIST

- B1, B2, B3—9-volt battery (NEDA, 1604)
  - J1—Miniature phone jack (Switchcraft, TA-2A or similar)
  - M1—Microammeter, 100  $\mu$ A full scale,  $3\frac{1}{2}$ " square (Allied Radio Cat. No. 52A7202 or similar)
  - Q1, Q4—FET (Motorola, HEP 801)
  - Q2, Q3—Npn transistor, (Motorola HEP 50)
  - R1—22,000-ohm,  $\frac{1}{2}$ -watt resistor
  - R2, R9, R12, R15, R18—22-megohm,  $\frac{1}{2}$ -watt resistor
  - R3—15-megohm,  $\frac{1}{2}$ -watt resistor
  - R4—4.7-megohm,  $\frac{1}{2}$ -watt resistor
  - R5—2-megohm,  $\frac{1}{4}$ -watt, linear taper potentiometer (Mallory, MTC26L4)
  - R6—18-megohm,  $\frac{1}{2}$ -watt resistor
  - R7—1.5-megohm,  $\frac{1}{2}$ -watt resistor
  - R8—1-megohm,  $\frac{1}{4}$ -watt, linear taper potentiometer (Mallory MTC16L4)
  - R10—470,000-ohm,  $\frac{1}{2}$ -watt resistor
  - R11—500,000-ohm,  $\frac{1}{4}$ -watt, linear taper potentiometer (Mallory MTC55L4)
  - R13—150,000-ohm,  $\frac{1}{2}$ -watt resistor
  - R14—100,000-ohm,  $\frac{1}{4}$ -watt, linear taper potentiometer (Mallory MTC15L4)
  - R16—47,000-ohm,  $\frac{1}{2}$ -watt resistor
  - R17—25,000-ohm,  $\frac{1}{4}$ -watt, linear taper potentiometer (Mallory MTC253L4)
  - R19—15,000-ohm,  $\frac{1}{2}$ -watt resistor
  - R20, R21—10,000-ohm,  $\frac{1}{4}$ -watt, linear taper potentiometer (Mallory MTC14L4)
  - R22—1000-ohm, linear taper, potentiometer (Mallory U4)
  - R23, R25—18,000-ohm,  $\frac{1}{2}$ -watt resistor
  - R24—1000-ohm,  $\frac{1}{4}$ -watt, linear taper potentiometer (Mallory MTC13L4)
  - R26—10,000-ohm,  $\frac{1}{2}$ -watt resistor
  - R27—1-megohm,  $\frac{1}{2}$ -watt resistor
  - R28—390,000-ohm,  $\frac{1}{2}$ -watt resistor
  - S1—D.p.s.t. toggle switch
  - S2—7-position, 2-section, nonshorting rotary switch (Centralab, PA-1005 or similar)
  - S3—D.p.d.t. pushbutton switch
  - Misc.—Plastic case with cover  $6\frac{3}{4}$ " x  $5\frac{1}{4}$ " x  $2\frac{1}{4}$ "; miniature two-conductor plug to fit J1; shielded test lead; miniature alligator clip (2); test prod;  $5\frac{5}{8}$ " x  $4\frac{3}{4}$ " perforated board; push-in terminals (40); battery holders and clips (3); transistor sockets (4); wire; solder; etc.
- Note: All resistors  $\pm 10\%$  unless otherwise indicated.

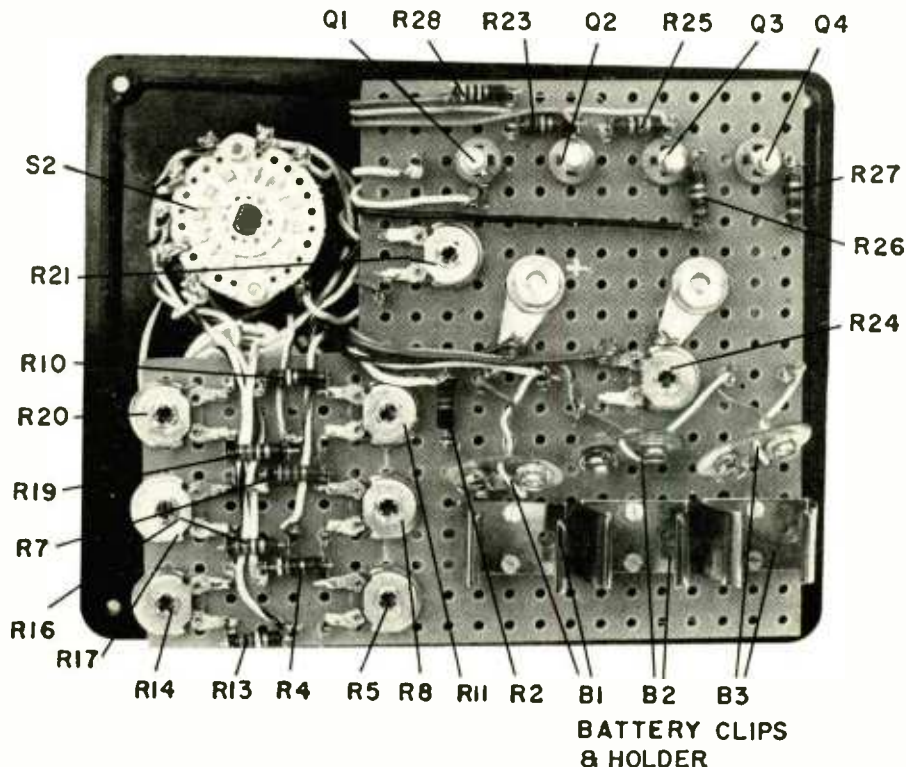
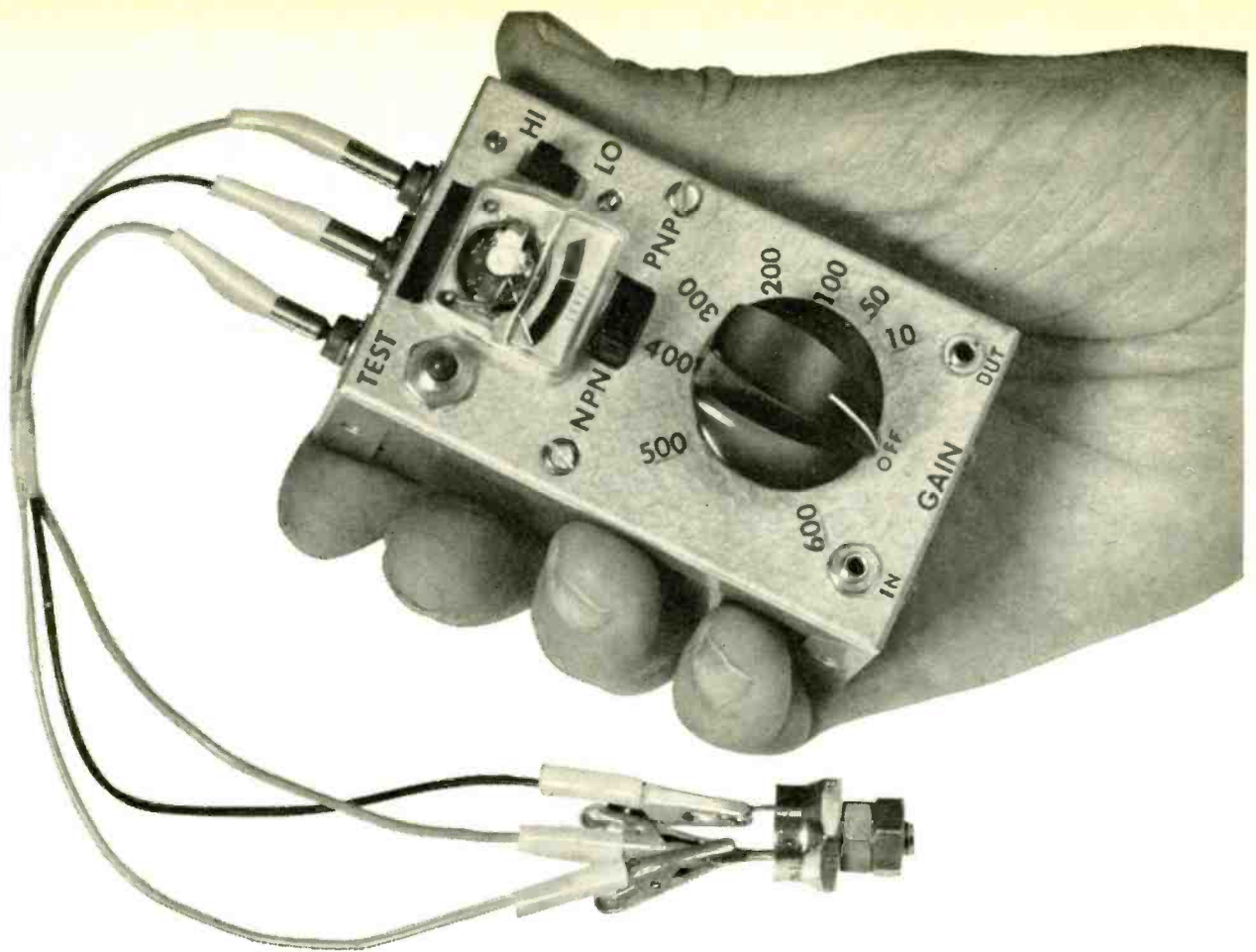

Fig. 3—Component layout is not critical, but save time and follow this arrangement.



# BUILD TRANSISTOR AND DIODE MINI-TESTER

Test for leakage, shorts, opens and gain characteristic plus built-in audio amplifier to determine a transistor's optimum operating point By JAMES T. RANDALL

NOT MUCH BIGGER THAN a pack of king-size cigarettes, this handy instrument can be used to test quickly most transistors and diodes. It will identify pnp and npn types regardless of power ratings, and test for leakage, shorts and opens. You can also use it to determine the direct-current gain of transistors with betas ranging from about 10 to more than 600.

Another unusual feature for such a simple, inexpensive tester is the ability to check the performance of transistors in the Mini-Tester's built-in audio amplifier circuit. You can also quickly determine a transistor's correct emitter-base bias current for operation in an audio amplifier circuit.

Pin jacks J2, J3 and J4 in parallel with a universal transistor socket (SO1) enable you to test all types of transistors regardless of size or terminal arrangement.

**Theory.** Slide switch S3 (Fig. 1), shown in the pnp position, applies battery voltage (B1) to the transistor under test. This switch establishes proper polarity for the meter as well as for the

battery. Switch S1 is really not needed as no current can flow when a transistor or a diode is not plugged into the tester. However, this switch will protect the battery against shorted leads when the tester is not in use. Resistors R1 and R2 control the amount of current flow in the base-emitter circuit, and M1 indicates the amount of current in the collector-emitter circuit.

Momentary-make switch S2 (TEST) holds base current off until depressed. To determine dc beta it is normally necessary to determine the ratio of the direct collector current to the direct base current, but all of the math work is eliminated simply by calibrating R1 to read out gain directly. Using resistor R1 you can vary the base current from about 12 to 1,000  $\mu$ A. To test an npn transistor, it is only necessary to slide switch S3 to the NPN position.

To measure the performance of a transistor as an audio amplifier, or to use the Mini-Tester as a preamplifier, a low-level audio signal is fed into J1 and coupled to the base circuit through capacitor C1. This signal is amplified

and appears at output jack J5. Stepup transformer T1 lets you monitor the signal with an inexpensive crystal earphone. If the Mini-Tester is going to be used frequently as an audio preamplifier, you can replace S2 with an spst slide switch to eliminate the need to hold the button down.

Diodes are tested by connecting them to jacks J2 and J4. Relative front-to-back current ratios and leakage can be determined by the meter reading and the setting of R1. Switch S4 acts as a high/low range selector for current readings. It switches meter shunt resistor R3 in and out of the circuit.

**Construction.** Component location and wiring are not critical, but because of the Mini-Tester's small size, you should be careful to lay out the panel to accommodate all the parts. Mount the battery holder far enough to the rear of the case to prevent R1 from blocking the removal and replacement of batteries. The transistor socket and the transformer can be held in place with epoxy cement. Mount T1 as close

to R1 as possible—as shown in photo. Be sure to allow enough clearance on the box sides for the cover to fit.

The test leads for J2, J3 and J4 should be about 5 inches long, each with a pin plug on one end and a miniature alligator clip on the other, for connection to the transistor under test. Use color-coded leads to prevent mistakes in making the connections.

Capacitor C1 should be a non-polarized electrolytic. This type is relatively expensive and often hard to find. Its specifications are not critical in this circuit. You can use any value between around 35 and 70  $\mu\text{F}$  at 6–10 volts. Instead of a nonpolarized unit, you can use two subminiature polarized electrolytics connected in series back-to-back. Use two 100- $\mu\text{F}$  electrolytics in series.

**Calibration.** If you don't want to make any marks directly on the case, make a dial scale out of heavy white cardboard about 1½ inches in diameter. Cement the cardboard on the panel face, under R1's pointer knob. Plug a dc microammeter into base-emitter jacks J2 and J3, and turn the tester on. Depress TEST pushbutton S2 and note the current reading on the microammeter. Slowly rotate R1 clockwise until you read an input current of 16.7  $\mu\text{A}$ . Mark this point on your dial scale to represent a current gain of 600. Continue this procedure until all of the values shown in the table have been obtained, and the dial scale has been marked accordingly. The settings depend upon proper battery voltage.

The no-math approach is possible because R1 is precalibrated and M1 operates with a "fixed" 10 mA. The value of R3 should be selected to make the silver line at the end of the black scale on M1 represent 10 mA. Without the shunt this line represents approximately 250  $\mu\text{A}$ . (Disregard the full-scale rating of the meter; you are go-

Calibration Data For Current, Gain and Resistance

Emitter-Base Current $\mu\text{A}$	R1 Resistance 1,000 ohms	Gain Beta
12.5	240	800
16.7	180	600
20.0	150	500
25.0	120	400
33.3	90	300
50.0	60	200
100	30	100
134	22	75
200	15	50
1,000	3	10

Values shown are for an emitter-collector current of 10 mA

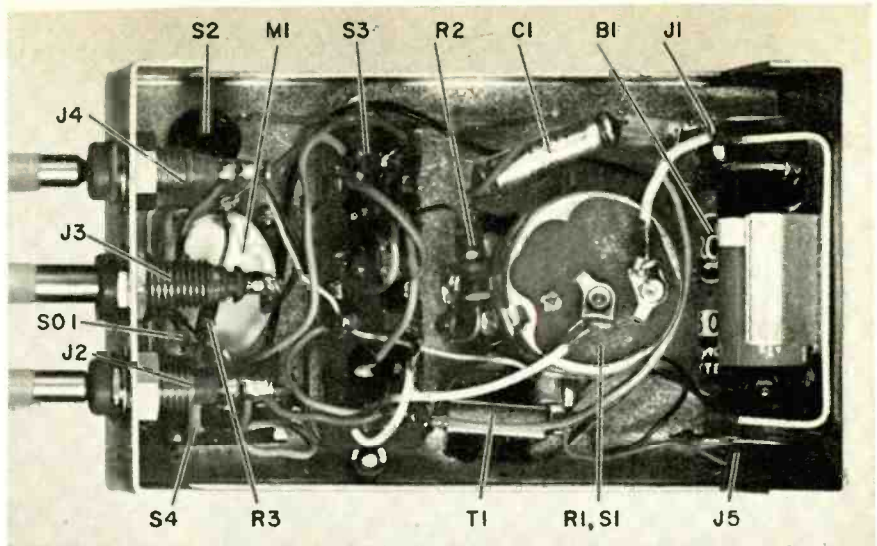

You can use a larger box, or you can work carefully and keep the "mini" look.

ing to use only the silver reference line.) The value of R3 (2 to 10 ohms) is critical and it may be more convenient to use a miniature potentiometer in its place. You will need to connect a milliammeter temporarily in series with M1 to see that there is an actual current flow of 10 mA when selecting the final value of R3.

**Operation.** To test a transistor either plug it into S01 or connect it to J2, J3 and J4. Connections to emitter, base and collector must be properly made.

Set S3 in the proper position and switch S1 on. When S2 is open the base current is zero and the emitter current is relatively low in a good transistor. Shorted or "leaky" transistors will have high current flow.

However, most germanium transistors will draw enough current for a full-scale meter reading when S4 is in the LO position. Many germanium power transistors draw as much as 2 mA and require a HI setting for S4.

continued on page 93

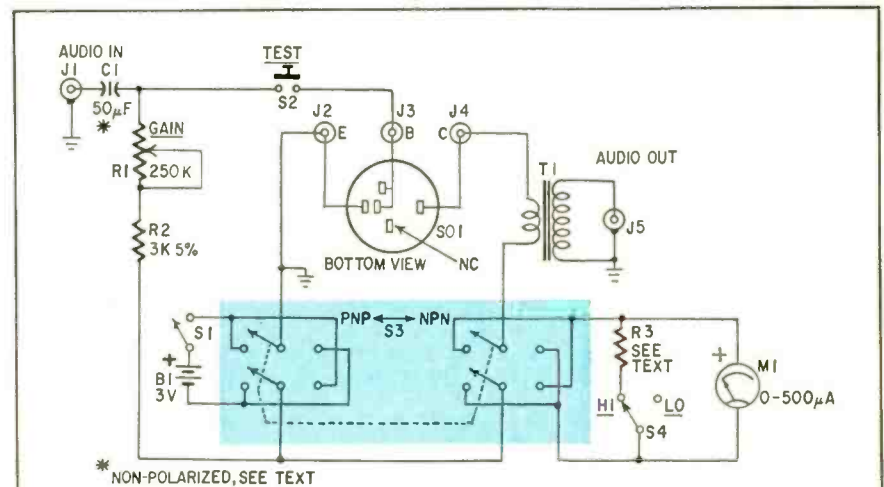

Fig. 1—Switch S3 reverses polarity to test pnp and npn transistors. Control R1 is calibrated to provide direct readout of gain and optimum bias.

- Parts List**
- B1—1½-volt cells (NEDA 910 or similar, 2 required)
  - C1—50- $\mu\text{F}$ , 6-volt, nonpolarized electrolytic, see text
  - J1, J5—subminiature phone jacks
  - J2, J3, J4—insulated tip jacks
  - M1—miniature meter, 500- $\mu\text{A}$  full scale (Lafayette 99 H 5036 or similar)
  - R1—250,000-ohm potentiometer, linear taper
  - R2—3000-ohm, ½-watt, 5% resistor
  - R3—½-watt resistor (see text)
  - S1—Spst switch (mounted on R1)
  - S2—Pushbutton switch, momentary-contact, N.O., subminiature
  - S3—4-pdt slide switch, miniature
  - S4—Spst slide switch
  - S01—transistor socket (universal type)
  - T1—transformer, 200,000/1000 ohms (Lafayette 99 H 6034 or similar)
  - 1—3½" x 2½" x 1½" metal box
  - MISC—Test leads, battery holder, knob, wire, solder, etc.

# REPAIR CB TALK TROUBLES



Service techniques to get the most out of that transceiver

By E. F. RICE and ANDY MUELLER

A GREAT MANY CB TRANSCEIVERS ARE brought into the shop with complaints of distorted sound or insufficient volume, or both.

Troubleshooting a transceiver can be simplified considerably by determining beforehand whether the trouble exists only on transmit, only on receive, or on both modes of operation. It is fairly easy to determine which circuits are common to both the transmit and receive functions and which circuits are used independently

for one mode or the other.

It is a good practice first to be sure that the transceiver is properly operating as a receiver. Chances are that when a trouble does appear, getting the receiver function to work properly will clear up most if not all of your talk troubles.

#### Locating the trouble

If you have any difficulty in identifying any of the circuits, or their func-

tions, refer to the manufacturer's service manual. The literature usually has a block diagram or a schematic as well as important service data and operation notes. Certain specialized test equipment is available with specific instructions in the use of the equipment and how to make certain tests.

Couple some experience with the right set of tools and you are ready for business. Here are a few common troubles and how they were remedied.

A solid-state transceiver with

modulation and rf circuits similar to those shown in Fig. 1 developed low volume on receive and showed a maximum of only 50% modulation on transmit when checked with a modulation meter.

Had we lived up to the practice-what-we-preach slogan, we could have saved a few steps by not paying any attention to the Q2 and Q3 circuits, since these circuits operate in the transmit mode only, and since the trouble was also present in the receive mode. But, from experience we almost automatically start with a quick check of the final stages.

A voltmeter check of the collectors on rf-driver Q2 and final stage Q3 showed normal voltages. Diode D1, the negative-peak clipper, was suspected even though it seemed unlikely that it could have much effect on the volume level in the receive mode. Also a waste of time . . . it checked out okay.

### Process of elimination

The quick and dirty approach having failed, we headed for the circuits that are common to both the receive and transmit modes. The R/T switch was flipped to the receive position and a modulated signal was loosely coupled to the antenna to enable some signal-tracing activity with aid of a scope.

There was plenty of audio signal at the input to Q1, but the scope showed very little gain when the signal

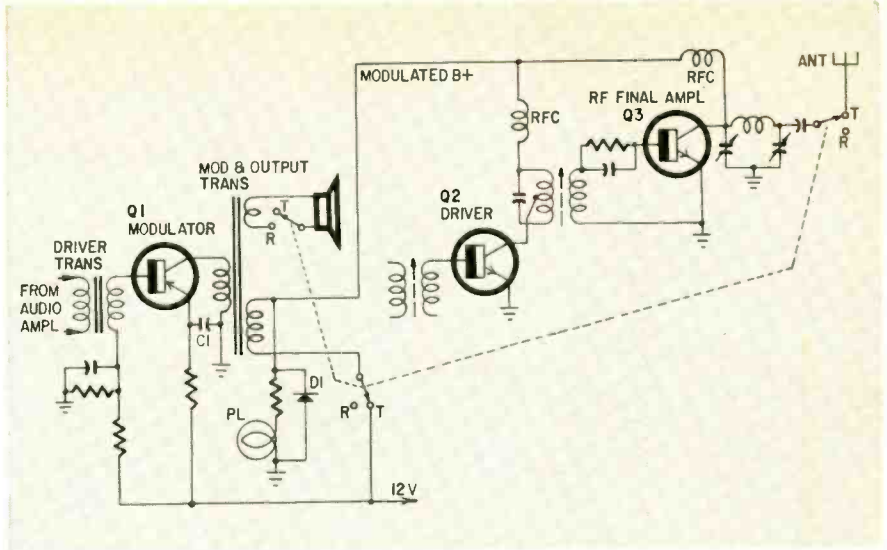

Fig. 1. Trouble that appears to plague a transceiver in both the receive and the transmit modes is most likely to appear in a circuit that is common to both functions. Defective capacitor C1 caused low volume on receive, and low modulation on transmit.

across the modulation transformer primary was viewed. This isolated the trouble to the modulator stage. The transformer and all voltages checked normal. This left only two possibilities: (1) the transistor had developed a defect which reduced its gain, or (2) the emitter bypass capacitor C1 was open, and increased the degenerative feedback of the stage to reduce its gain. Sure enough, it turned out to be the capacitor.

A similar defect, a faulty cathode-bypass capacitor C2, caused entirely different symptoms in the tube-type

unit shown in Fig. 2. This time the capacitor was shorted. There was plenty of audio, but it was distorted. The 6BQ5 modulator tube also seemed to go bad frequently. The faulty capacitor shorted out the cathode resistor and caused an increase in plate current beyond safe operating levels.

A popular CB transceiver came into the shop with very-poor-quality audio in the transmit mode. The receiver sounded okay. A check with the modulation meter showed about 40% modulation on peaks. There also was a definite drop in output power with modulation. Downward modulation is usually due to insufficient bias or excitation of the modulated rf amplifier, improper load resistance or overloading the stage.

### Removing gimmicks

Checking the schematic (Fig. 3), we noticed that R1—a 4,700-ohm resistor—had been illegally “jumpered” with a piece of wire in an apparent attempt to increase the input power of the final amplifier. The result was that the output waveform did not properly increase with modulation. It did decrease on negative peaks of audio.

Too often not-too-expert operators try gimmicks to increase the power of CB rigs. Besides being illegal, such changes usually do not make a noticeable improvement. More often than not, they actually reduce the audio level and increase the amount of distortion.

Some rigs come in with downward modulation trouble caused by a bad case of “screwdriveritis”. Simply following the step-by-step instructions for modulation adjustments given by the manufacturer solved the problem neatly.

R-E

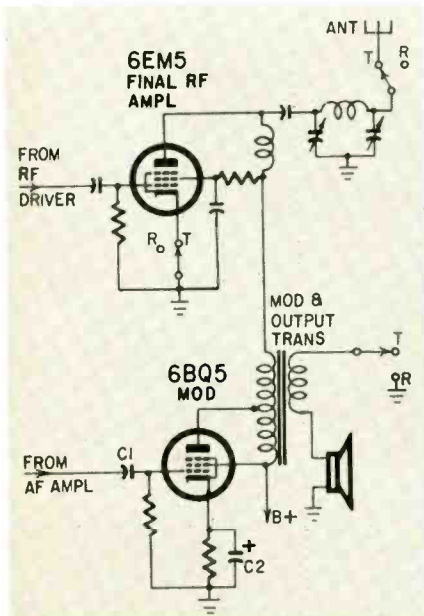

Fig. 2—In this transceiver, audio was distorted in both transmit and receive modes, but clean up to the 6BQ5 grid. Capacitor C2 was shorted, bypassing cathode resistor and increasing plate current.

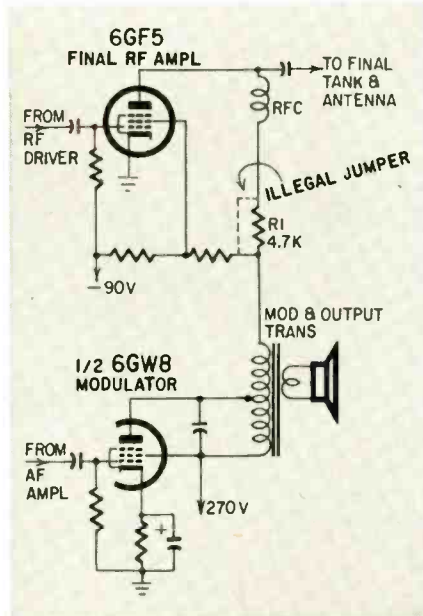
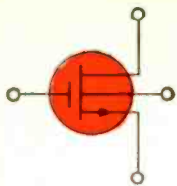

Fig. 3—A case of downward modulation was caused by this illegal jumper someone had used in an attempt to increase the input power to the final. Removing jumper corrected the trouble.



# WHAT'S A MOS FET?

Newest type of transistor simplified

By GENE L. JACKSON\*

**IF** the conventional junction-type transistor weren't already established, the MOS FET (*Metal-Oxide Semiconductor Field-Effect Transistor*) would have been developed instead. That's the opinion of many top scientists and engineers who have spent years experimenting with both kinds. Such comments suggest how dramatically versatile this new semiconductor is.

The principle of the MOS FET† has been known for many years, but only recently has the state of the semiconductor art reached the point where practical MOS FET's could be manufactured on a production basis. Early MOS FET's were unstable and permanently affected by high temperatures.

Some of the advantages of the MOS FET over other types of transistors:

1. A much higher input impedance
2. Lower noise
3. Lower stray capacitance
4. Better thermal stability
5. Wider frequency response
6. More uniformity from unit to unit.

There are two types of MOS FET's: the *depletion* and the *enhancement* type. Fig. 1 is a simplified cross-section of the depletion type. Notice that the drain and source regions are connected by a very thin channel of n-type crystal. The gate lead is connected to a metal electrode which in turn is separated from the n-type semiconductor channel by a layer of silicon dioxide. This layer of silicon dioxide is extremely thin and is the secret to successful MOS FET operation.

As is the case with the junction FET, appropriate bias voltages applied between gate and source electrodes can deplete the channel of its active current carriers. This is accomplished by the electric field in the gate region, very

much like the action of a tube's grid. The conductivity of this MOS FET conduction channel can be "enhanced," or increased, as well as "depleted."

Because the gate is well insulated and is nonrectifying (that is, no current can flow into or from the gate electrode), the input resistance remains high with either type of operation and the power of the transistor is not affected. What's significant is that while current can flow through the MOS FET (from source to drain) with zero bias between the gate and the source, this current can be increased or decreased by applying the proper bias or signal voltage between these two electrodes. These two modes of operation, called the *enhancement mode* and *depletion mode* respectively, are both applicable to the depletion type.

The current in the MOS FET does not cross a pn junction as in a conventional transistor. That eliminates minority-carrier problems and consequently many disadvantages inherent in the conventional transistor.

## Enhancement Type

A simplified cross-section diagram of the enhancement type MOS FET is shown in Fig. 2. This type is identical to the depletion type except that the physical channel between the source and the drain does not exist. Because current cannot flow without *some* type of channel in a field-effect transistor, the enhancement-type MOS FET can be operated only in the enhancement mode. A bias must be applied between the gate and the source to "create" a channel.

In Fig. 2, when a bias voltage is applied so that the gate is positive with respect to the source, electrons are drawn into the region beneath the gate electrode. With enough bias voltage, the p-type crystal immediately next to the

gate and between the source and drain regions gains enough electrons so that it begins to act like an n-type crystal. Thus the necessary "channel" is formed. The width and conductivity of this channel are proportional to the voltage applied. Again the current can be controlled through the device without drawing any current from or into the gate electrode, leaving the input impedance very high at all times.

While only n-channel devices have been mentioned so far, p-channel MOS FET's are also commercially available. The n- and the p-regions, and the polarities of the applied voltages, are reversed (as in pnp and npn transistors).

Unfortunately, symbols for MOS FET's are not yet standardized. Fig. 3 shows some of the symbols now used. All examples are n-channel type. The p-channel symbol is identical, except that the direction of the arrowheads is reversed. The substrate connection can be brought out of the case as a separate lead, or connected internally to the source electrode.

## Beware of Electrostatics

The MOS FET isn't perfect—it has a disadvantage inherent to insulated-gate devices. It can easily become permanently damaged by a relatively low voltage across its leads. The insulating layer of silicon dioxide to which the gate electrode is connected is made very thin to allow good control over the conducting channel with a low gate-to-source bias voltage. That same thinness allows this layer to be easily punctured. Because any current through this silicon dioxide layer results in permanent damage, a static charge on your body or clothes can ruin a MOS FET. A large electrostatic charge can accumulate on the electrodes if the MOS FET slides around

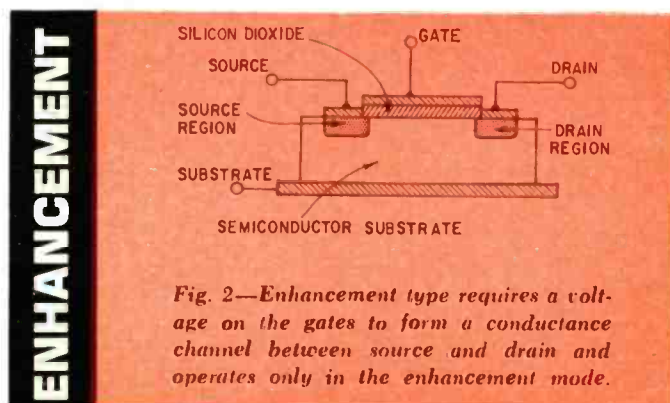
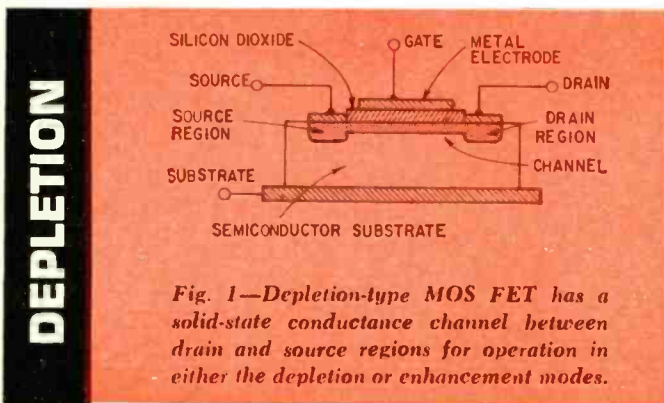

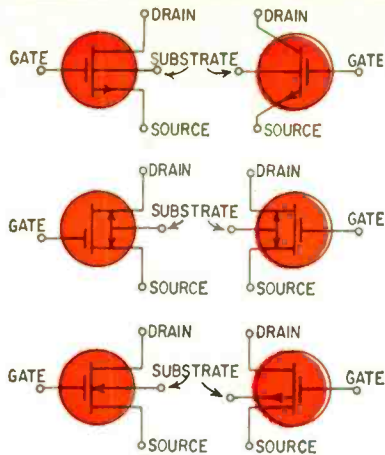

Fig. 3—Unfortunately, MOS FET symbols appear to vary as the number of manufacturers. Here are just a few you will find in schematics.

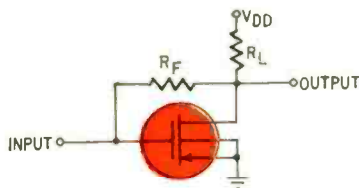
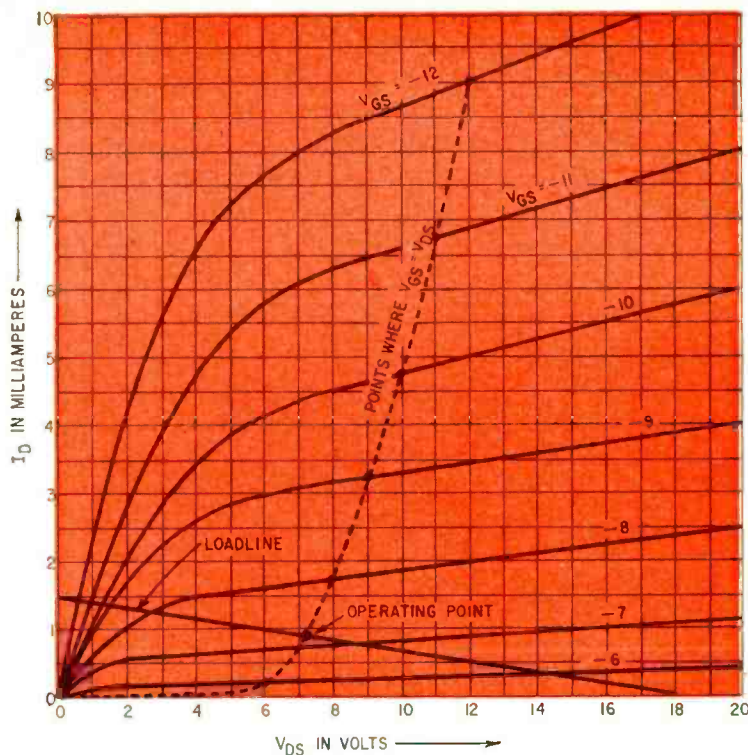

Fig. 4—Schematic diagram of the basic p-channel MOS FET preamplifier used to plot curves in Fig. 5. The FET can operate in a manner similar to a pentode vacuum tube.

### DRAIN CURRENT-VOLTAGE RELATIONSHIP



DRAIN CHARACTERISTICS CURVES WITH 12K  $R_L$   
LOADLINE AND  $V_{GS} = V_{DS}$  POINTS CURVE.

Fig. 5—As the voltage across the drain and source increases, drain current increases. Operating point is the intersection of the load line and the line representing equal voltage across the gate and the drain, both with respect to the source. Load resistance  $R_L$  is 12,000 ohms.

in its packing material or if its leads are rubbed or brushed against clothing or other fabrics during handling. For this reason, MOS FET's (like meter movements) are usually shipped and stored with the leads tied together electrically with conductive foil or by some other means.

Some precautions to prevent damage to MOS FET's (and all FET's) during handling and in circuits:

1. Always keep the leads connected together electrically until they are connected into a circuit.
2. Get the habit of watching for accumulation of potentially harmful static charges. Ground yourself and your equipment before handling FET's.
3. Use only soldering irons with grounded tips when working with MOS FET circuits.
4. Be sure the MOS FET and the circuit it is to be connected to are at the same potential before touching the two together.
5. Be sure that power supplies used with FET's do not produce excessive voltage transients, especially when they are turned on or off. These precautions shouldn't fright-

en you from taking advantage of these new devices. With proper handling, damage to MOS FET's should be extremely rare. After installation in the circuit, there is very little chance of damage because the circuit impedances should be low enough to prevent buildup of voltages high enough to cause damage.

The MOS FET is especially good for preamplifiers, oscillators and other low-level circuits where high impedance and good frequency response are important. In many respects, it combines the advantages of both transistors and tubes, without their disadvantages.

#### Resembles Pentode Tube

A basic preamplifier circuit using an enhancement-type MOS FET is shown in Fig. 4. It can be used with a microphone, a phonograph or guitar pickup or for any other low-level signal application. The  $R_F$  value isn't critical—it could be as high as several hundred megohms—because no gate current is drawn by the bias circuit. A nominal value would be 22 megs, which is large enough to present a high enough input impedance for most applications. If you want an extremely high input imped-

ance,  $R_F$  may be increased in value.

The MOS FET shown in Fig. 4 is a 2N3608, made by the Microelectronics Division of Philco-Ford. Single-quantity price is \$8.05.

The resistance of  $R_L$  is selected to match the characteristics of the MOS FET and other circuit values. Generally, as the resistance of  $R_L$  is increased, voltage gain and output impedance increase, and input impedance decreases. The input impedance is approximately the  $R_F$  value divided by the voltage gain.

As an example of the process of selecting circuit values, refer to Fig. 5, a series of drain curves for the preamplifier. The dashed line represents the points where  $V_{GS}$  equals  $V_{DS}$ . The load line is drawn for a supply of 18 volts with  $R_L$  equal to 12K. The point of intersection of the load line and the dashed line represents the quiescent or self-bias point.

Small-value coupling capacitors will work well with this preamp, because of the high impedances involved.

Many possible applications for MOS FET's are only now coming into view. As cost drops, MOS FET's will show up more and more in commercial equipment.

R-E

# RADIO & TV

## TROUBLES

Sets with more than one defect often confuse the technician

By HOMER L. DAVIDSON

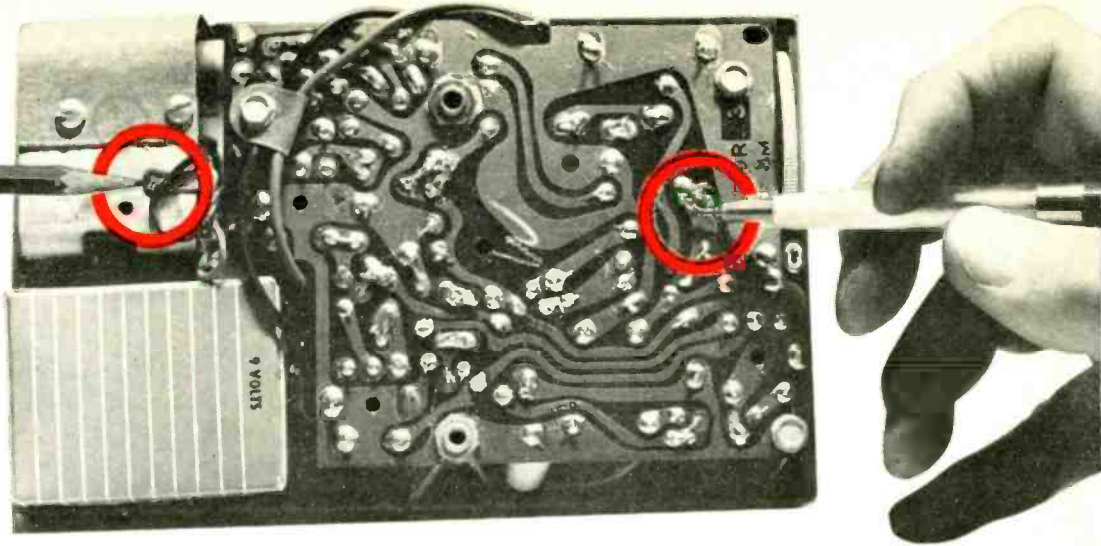

HOW MANY TIMES HAVE YOU BUTTONED up a radio or TV set and pronounced it fit and faultless only to have another symptom pop up? This has happened to me many times, and yet I sometimes wonder how I can be so misled after giving the chassis a good going-over. Here are several cases in which I found at least two troubles in the same set and what I did about them.

A G-E transistor portable radio, model P-755A, had an audio whistle and low volume and could pick up only one local station. A defective filter capacitor C3 (Fig. 1) solved the whistle problem and stations were returned to near normal.

But the problem of low volume remained, so each stage was checked for signal loss. An audio signal was injected at the volume control and traced forward toward the speaker. Coupling capacitor C5, between Q4 and Q5, was found to be leaking and was replaced with a new one. When transistor radios reach the ripe old age of 5 or 6 years, it is always wise to check coupling capacitors for opens and leakage.

Another transistor radio had a couple of troubles in it, both at the same spot as it turned out. A Westinghouse radio, model H-795P6, was completely

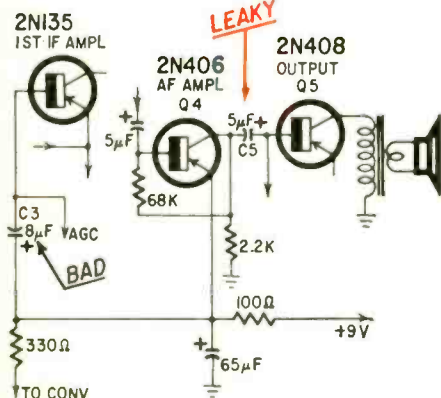

Fig. 1—G-E P-755A had two troubles: Bad C3 caused audio squeal; C5 low volume.

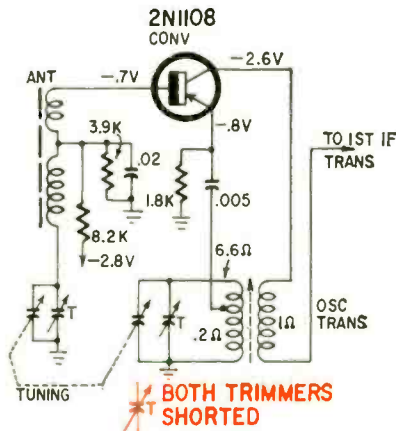

Fig. 2—Shorted antenna and oscillator trimmers disabled the receiver and almost threw the service technician for a loss.

dead, except for a low-level hiss.

An audio signal injected at the volume control showed the audio stages were okay. An rf signal injected into the antenna circuit (Fig. 2) failed to get through. But when the i.f. signal was injected at the collector of the converter, the signal could be heard from the speaker. The 2N1108 converter transistor was removed and checked. It proved to be good.

I examined the antenna and oscillator sections of the tuning capacitors. The plates were quite close, but they were not touching. Next, I disconnected the antenna coil. The ohmmeter showed a short in the antenna tuning capacitor. I rotated it, but the short remained. If the plates were at fault, the intermittent contact resulting from rotation would have caused an erratic reading on the meter.

There was only one thing left, the antenna trimmer capacitor. Sure enough, when the trimmer screw was backed out, the short disappeared. A new mica washer was placed under the thin plate and the screw returned to its position. Now there was no measurable continuity, and that was good.

The antenna coil was soldered into

place and the set switched on—and nothing happened! Deader than a door-nail!

This time I disconnected the oscillator coil from the variable capacitor; it checked out okay. If the antenna trimmer was bad, maybe the oscillator trimmer was also bad. I had never seen both of these short out at the same time. Sure enough, the oscillator trimmer was shorted. I replaced its small mica insulator and reconnected the coil. A careful realignment restored normal operation. (I assume that the owner or a tinkerer had run the screws in tight and they had eaten into the insulation.)

Let's look at a few of TV's two-in-one troubles. One RCA KCS122BD chassis produced very snowy pictures on all vhf channels. On uhf, channel 21 had a very good picture, but the set would go into an uncontrollable roll at the slightest provocation.

Here were definitely two troubles in one. I surmised that the vhf tuner had trouble in it and that the vertical sync section was bad. The uhf tuner feeds into the oscillator and mixer stage of the vhf tuner. The uhf picture was good

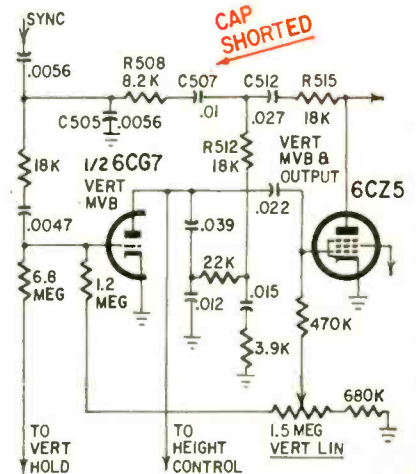

Fig. 3—Isolating the trouble in this vertical deflection circuit was tougher than finding the burned-out antenna balun coil.



so it had to be the rf section of the vhf tuner that was faulty. I pulled off the lid that covers the antenna coils. Sure enough, lightning had gotten to the balun coils—they were burned and open at both ends. It is always wise to change both balun coils if either one is bad. The replacement was made and channel 5 was as good as channel 21.

Next, I went to the vertical section and checked voltages. All were practically normal. Rotating the height control, I noted that in one spot near the end of rotation the control was scratchy. The 5-meg control was suspected, but held up when checked with an ohmmeter.

Capacitor C512 (Fig. 3) at the plate of the 6CZ5 tube was checked for leakage. This capacitor has broken down in many vertical circuits and was naturally suspect. This time it was okay.

The ohmmeter showed that capacitor C507, a .01- $\mu$ F paper type, was shorted. Replacing it restored the set to normal operation.

An Admiral 20UG6 chassis was troubled with intermittent brightness and horizontal lines. The left-hand side of the screen was jagged. When the brightness went off, a horizontal squeal could be heard in the flyback section. Brightness could be made to come and go by rapping the chassis. I tapped around the filter capacitor and power transformer, and out went the brightness. Replacing the capacitor apparently ended the trouble.

At least I thought so, until the first half-hour had elapsed. The darn thing started pulling horizontally and acting as if the horizontal was out of sync. Also, I heard the squeal again. Was it sync trouble? I checked the horizontal phase discriminator. One diode was bad. A replacement cleared up the trouble.

Here's one in a color receiver that kept me guessing for awhile. Actually, this double trouble at the same spot in an RCA CTC10A color chassis (Fig. 4)

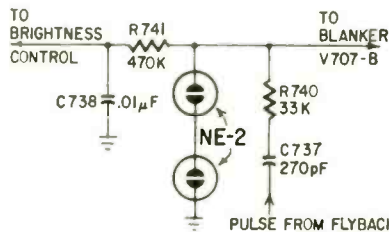
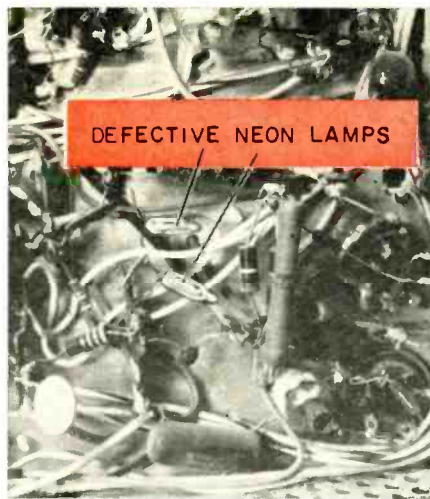

Fig. 4—Two bad neon lamps caused intermittent brightness in the CTC10. The photograph and diagram show their location.

showed two symptoms. The set had poor brightness and loss of color. When the brightness was turned up, the raster pulled in about 4 inches on each side. The low voltage was good. Replacing the horizontal output tube helped a little, but not enough to solve the problem. All the tubes in the horizontal and high-voltage sections checked out good.

However, two neon lamps under the chassis were brighter than usual, and I knew they were part of the color-blanking circuit. Since color was also affected, the two troubles might be caused by the same component. I was right. The two NE-2 lamps were replaced, and color and brightness were restored. Even the width problem was gone. **R-E**

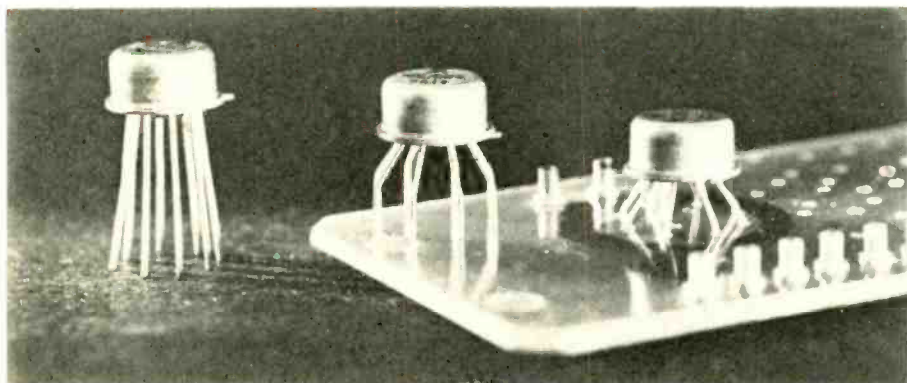

Photo: Motorola Semiconductor Products, Inc.  
"Take me to your leader!"

## color coded nutdriver sets in new "keep and carry" cases

Sturdy plastic cases keep nutdrivers in order on the workbench. Tight fitting, snap-lock covers protect tools when not in use, permit carrying them on service calls without danger of spilling or becoming lost in tool box.



### No. HS-6-18 HOLLOW SHAFT NUTDRIVER SET

10 Hex Openings:  $\frac{3}{16}$ ",  $\frac{7}{32}$ ",  $\frac{1}{4}$ ",  $\frac{9}{32}$ ",  $\frac{5}{16}$ ",  $\frac{11}{32}$ ",  $\frac{3}{8}$ ",  $\frac{7}{16}$ ",  $\frac{1}{2}$ ",  $\frac{9}{16}$ ". Yellow, slipover cover case.



### No. 77 DRILLED SHAFT NUTDRIVER SET

7 Hex Openings:  $\frac{3}{16}$ ",  $\frac{7}{32}$ ",  $\frac{1}{4}$ ",  $\frac{9}{32}$ ",  $\frac{5}{16}$ ",  $\frac{11}{32}$ ",  $\frac{3}{8}$ ". Hole depth  $1\frac{1}{4}$ ". Black, pebble grain, hinged cover case.

## professional quality

Precision fit, case-hardened sockets, polished and plated steel shafts; shockproof, breakproof, color coded plastic (UL) handles.

WRITE FOR BULLETIN N567

# XCELITE

XCELITE, INC., 10 Bank St., Orchard Park, N. Y. 14127  
In Canada contact Charles W. Pointon, Ltd.

Circle 25 on reader's service card

# THE WIDER THE BAND

*Part 2—Listener tests question the need for high-frequency response beyond 15,000 Hz in audio amplifiers—a report on an interesting experiment in high-fidelity sound*

By **PETER E. SUTHEIM**

DO YOU REMEMBER RADIO-ELECTRONICS' "great debate" in the March 1966 audio issue? The opponents were two audio engineers, both well known for their leadership in the design of high-fidelity amplifiers. The question was: Does extending the frequency response of a reproducing system (in this case, amplifiers) beyond the normally accepted limits of human hearing have any effect on the reproduced sound as perceived by a typical listener?

Robert E. Furst, vice president of engineering at Harman-Kardon, Inc., claimed that it does, partly because one of the consequences of restricted bandwidth is relative phase difference, or phase shift, between signals in the middle of the audio band and signals at either extreme. This, he claimed, is audible. He also felt that the "normally accepted" limits of human hearing are antiquated, and that more research needs to be done. Perhaps humans *can* hear frequencies outside the range of 20 to 16,000 Hz. And, in any case, roll-offs should not be fixed into the design of the amplifier, but available at the listener's option.

Victor Brociner, assistant to the president of H. H. Scott, Inc., accepted the 20–16,000 limits as valid and true, and asserted further that a wider range in reproducing equipment is pointless because present-day recordings and broadcasts do not contain higher or lower frequencies. Extending audio system response beyond those limits, furthermore, makes the system susceptible to turntable rumble and other disturbances, like switching transients, stereo subcarriers and record eccentricities. These affect the sound not only by adding noise to it, but by modulating the

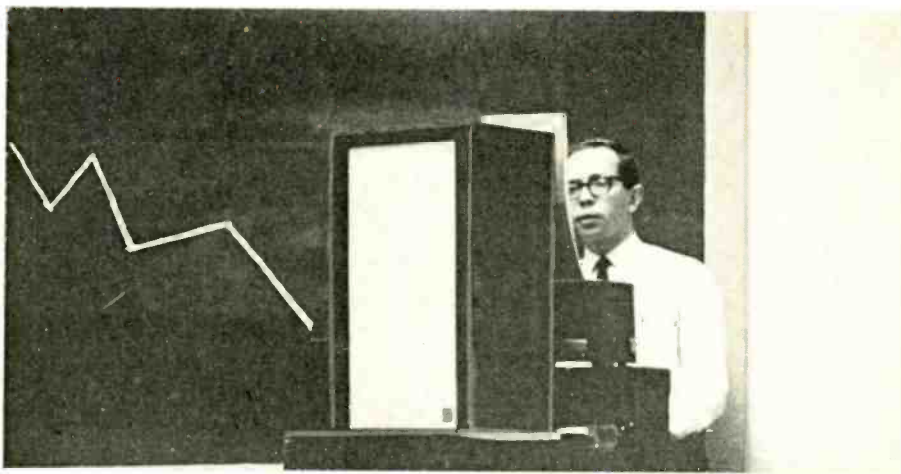

Dr. Lawrence Zeitlin of City College, New York runs through a series of the hearing tests.

audio and producing components impossible to filter out afterward.

Also, said Brociner, humans cannot hear the kind or degree of phase shift created in an amplifier where response is rolled off gradually just out-

side the 20–16,000-Hz range. He was willing to concede that stability considerations often make it necessary to broaden the response of an open-loop amplifier. But considered as a black box, an amplifier should reproduce the

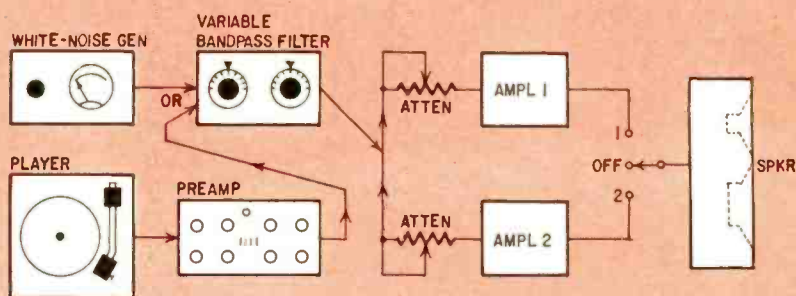

Fig. 1—The equipment and recordings used in the trials were:

- White-noise generator: Lafayette Laboratories
- Player: Acoustic Research turntable and tone arm, and Empire 888PE pickup cartridge
- Variable-bandpass filter: Krohn-Kite 315A, range 20 to 200,000 Hz, 12 dB/octave slopes
- Preamp: Marantz 7-T transistor stereo preamplifier
- Amplifier 1: Dynaco Stereo 120 transistor amplifier, one channel only, power bandwidth

approximately 5 to 100,000 Hz

Amplifier 2: Marantz 8-B tube amplifier, channels paralleled power bandwidth approximately 20 to 20,000 Hz

Speaker: Acoustic Research AR-3  
 Records: Excerpts from RCA Victor LSC-1992, Beethoven, Violin Concerto (Heifetz, violin; Boston Symphony Orch., C. Munch conducting) and excerpts from Columbia MS-6746, Kodaly, Hary Janos Suite (Philadelphia Orch., Ormandy, conducting).

## THE HIGHER THE FI?

complete audio range and no more.

We received a batch of letters about that, and printed excerpts from some in the June 1966 issue (page 53). At that time we promised to look into the matter and see if we could devise an experiment that would settle the argument. One of the letters was from an associate professor of psychology at City College of New York, Dr. Lawrence R. Zeitlin. He had done a good deal of research on human hearing, the effects of noise, and related problems. We called him, and he was soon hooked on the challenge of designing a suitable experiment!

We agreed to try two kinds of sound on a listening panel, in two independent groups of experiments. One sound would be white noise from a diode noise generator, unfiltered and unadulterated, and the other would be musical material from fairly typical modern long-play recordings.

The listening panel consisted of 21 people available at the time—by no means a varied sample, but the bias introduced that way turned out more to reinforce the conclusions than to render them suspect. They were male psychology students, ages 18 to 36.

### Testing method

The basic experimental scheme was to produce bits of white noise (later, music) through a reproducing system (see Fig. 1 for the equipment we used) through a variable bandpass filter. The noise (and later, the music) was fed simultaneously via the filter to the inputs of two amplifiers—one, a high-quality, low-distortion tube amplifier with response deliberately rolled off by the manufacturer outside the conventional audio limits; the other a wide-range, low-distortion transistor amplifier.

A speaker was placed in front of the group so that all the members were seated within a 90° zone centered on the tweeter axis. The speaker could be connected to either amplifier by flipping a center-off toggle switch in one direction or the other. (Fig. 1 shows our hookup.) Before the experiment began, the speaker was switched from one amplifier to the other to check for equal output conditions from both amplifiers. The sound-pressure levels were equal-

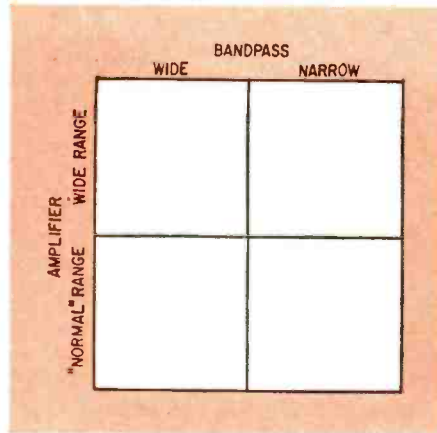

Fig. 2—The four cells in this diagram represent the four different tone bursts or conditions in each trial. Subjects were asked to listen to the bursts and to pair those that sounded most alike.

ized with the help of a General Radio sound-level indicator and a constant white-noise signal input. The sound-pressure level (SPL) was 83 dB, 1 meter from the speaker, on axis, and 76 dB, 5 meters away.

Each trial consisted of four short bursts of white noise, about 2 seconds per burst. One burst was through the wide-open filter and the wide-range amplifier; another from the filter narrowed by a known amount (known to us, but not to the subjects) and through the wide-range amplifier; another from the filter, widebanded, and the "normal-range" amplifier; and the last from the narrowed filter and the "normal" amplifier. That accounts for all four possible combinations. The order of these trials was shuffled at random throughout the

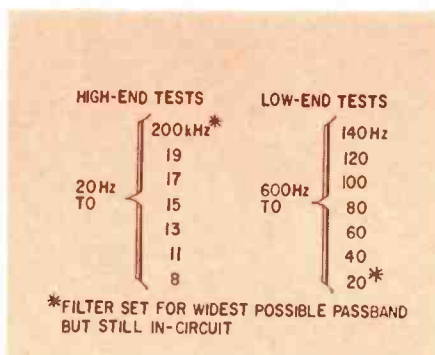

Fig. 3—A series of 20 trials was run for each of the 14 passbands shown above.

session, but according to a prearranged list so that we, the experimenters, could identify the subjects' answers.

For each trial, all four cells of Fig. 2 were completed. The subject was required to identify the pair of bursts that sounded most alike to him. This *stimulus-matching* response was used to eliminate one kind of bias. The subject did not have to choose between "better" or "worse." He did not know during the experiment exactly what was being tested, nor that two different amplifiers were being used.

Thus, if amplifier differences predominated, the subject would pair the two sounds coming through the same amplifier. If bandpass differences predominated, he would pair the sounds from similar filter settings. If there were no detectable differences within the group of four samples, a random pairing would result—that is, he would have to guess to produce a pairing.

We used pre-established passbands tabulated here in Fig. 3. A series of 20 trials was run at each of the indicated passbands.

### And the results?

In any experiment of this kind, there is always a computable probability that subjects will answer right by chance. If the results, when they are analyzed, indicate that the accuracy of the subjects' responses is no better than chance—that is, if they could have produced the same responses by haphazard guessing—then the experiment would be inconclusive. In this case, the chance figure was  $\frac{1}{3}$ . If the subjects' answers, checked against our table of correct responses, showed a score of  $\frac{1}{3}$  (or  $33\frac{1}{3}\%$ ) from most of the respondents, we would have to attribute the responses to practically pure guesswork. The way the experiment was set up, that would mean the subjects could not reliably distinguish among bursts in a group of four, and hence were unable to pair them reliably.

Just this began to happen when the high-end cutoff was raised to 15 kHz and above. For all high-end cutoffs above 15 kHz, there was no significant deviation from pure-chance pairing of amplifiers or passbands. At cutoffs of 11 and 13 kHz, subjects could pair *passbands* with slightly better than chance expectation. At no point were *amplifiers* paired bet-

## THE WIDER THE BAND, THE HIGHER THE FI?

ter than chance. These results are shown as a graph in Fig. 4.

At the low end, the results were so wildly contrary to experience and to other related experiments that they aroused our suspicion. Therefore those results are not given here. White noise is a poor choice of sound for low-frequency tests, since it is by nature deficient in low-frequency energy.

### The musical tests

In the music portion of the study, we used 13 male subjects, ages 19 to 32 (again, these were immediately available and we don't pretend that they constitute a proper sample). The subjects were seated in a 10 x 22-foot classroom with hard-surfaced walls. All sat within a 60° zone centered on the axis of the speaker. Preamplified and equalized music from the phono cartridge was passed to the variable bandpass filter and from there to the two amplifiers as before. The two amplifiers could again be selected one at a time with a switch to drive the single speaker system. Sound pressure levels on fortissimo passages were approximately 83 dB 1 meter away, 80.5 dB 5 meters away.

The procedure was identical to that used in the white-noise study, except that the music bursts were 5 seconds long. We took care to repeat nearly the same musical passages frequently to reduce errors that might be caused by different volume, orchestration, melody, etc. Passbands were the same as before, and each was tested for 20 trials.

Throughout this part of the experiment, pairings by amplifier were only at chance level. There appears to be no audible difference between the wide-range and normal-range amplifiers used in these tests. The fact that one (the "normal"-range) was a tube amplifier and the other (the wide-range) a transistor amplifier had no bearing on this conclusion. To assume otherwise is to say that if both had been tube amplifiers or both transistor, there might have been a difference. That seems unlikely.

In the music tests, the ability to pair signals by frequency range (bandwidth) started with a high cutoff between 13 and 15 kHz. By the time the high-end cutoff lowered to 8 kHz, pairing became virtually certain. At the low-frequency end, neither amplifier nor bandpass-related signals could be paired at better than chance levels. With the music signals we used, the low-end cut-

off had to be higher than 120 Hz before our panel could distinguish the narrow-band signal from a wide-range signal with any reliability. Here again, this is very much at odds with experience. Probably we would find a lower low-end cutoff if we used organ music.

Of course that's a tentative conclusion. It's likely to be received with all the skepticism, triumph, abuse and rejoicing that has always been accorded investigators. Some people will certainly ask, "What do you have against hi-fi?" and others will say "If it's good enough for the birds, it's good enough for me."

The tests described here are far from refined. The huge leaps within the chance region in Fig. 4 indicate that. Still, the design of the experiment is valid.

### Male bias

The use of males in a limited age group produces a bias; yet it is primarily men who buy and listen to high-fidelity systems, and primarily men between the ages of, say, 20 and 60. It is also well known that the high-frequency response of the human ear declines with increasing age, especially in males. While the results might be quite different from a panel of 14-year-old girls, they are not the majority of those who buy hi-fi systems.

Room acoustics, background noise, the quality of the speaker system, dispersion of high frequencies, the recorded material chosen, the seating position of the subjects with respect to the loud-speaker position—all influence the results. Certainly the outcome might have

been different with live music, but the purpose of the experiment was not to test human hearing. It was to determine whether an amplifier system with a frequency range greater than the apparent range of the ear has any effect on the quality of recorded music, the kind the majority of us listen to on our hi-fi systems.

A different speaker system might change the results slightly, although the speaker we chose can produce substantial acoustic energy with low distortion at the extreme ends of the sound spectrum. Even with that speaker, further restrictions in bandwidth could not be detected reliably until they fell well within the relatively flat range of the speaker. Except for a system whose output rises sharply at both ends of the spectrum (which would not, by definition, be a high-fidelity speaker), it is difficult to imagine that a wider-range speaker would have made any difference.

### Conclusions

It is still possible that when the ear listens directly to live music, sounds in the range between 20 and 30 kHz intermodulate with each other and with sounds between 10 and 20 kHz in the ear to produce sidebands or difference tones that we can perceive. If that is true, it would be a valid reason for extending amplifier power response well beyond 20 kHz. However, strong experimental evidence (not ours) indicates that this does not happen. And in any case, for that extended range to be of any use, recorded and broadcast material must also contain those higher frequencies (extremely little of it does, now) and pickups and speaker systems must be capable of passing them.

*At the present state of the art, and based on human hearing considerations alone, according to the evaluation of our panel's response, there seems to be no valid reason for designing amplifiers whose power bandwidth extends beyond 15 kHz at the high-frequency end.*

More refined tests are being designed as you read this. We'll publish our finding as soon as they're ready. In the meantime, we will be delighted to hear from you about the way the tests were conducted, or about anything else that delights or puzzles you, or makes you enjoy hi-fi. **R-E**

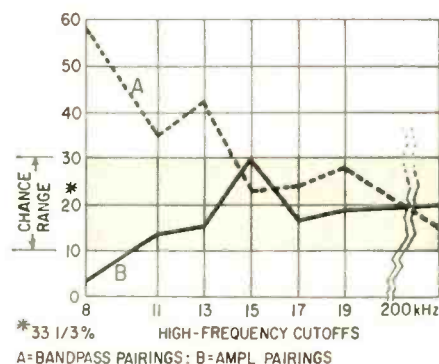

Fig. 4—At frequencies of 15 kHz and above responses showed no significant deviation from chance. More tests are planned.

# SIGNAL-TRACE FM-RADIO AND TV TUNERS WITH A FIELD-STRENGTH METER

By JOHN FITZGIBBON

*Easy tests for operation, alignment, sensitivity and gain per stage*

ONE OF THE MOST OVERLOOKED instruments outside the antenna segment of the electronics business is the field-strength meter (FSM). Sure, you can set up antennas with it, but don't forget it is a sensitive tuned-rf voltmeter. Some instruments have full-scale deflection ranges as low as 50 and as high as 50,000  $\mu\text{V}$ . Those designed for TV work can tune from 54 to 216 MHz and some also cover the UHF band. They are excellent rf signal tracers especially for the front ends of FM and TV sets.

There are a lot of different FSM's, all the way from my old Simpson 188 up to the latest transistor vhf/uhf instruments. Some are very accurately calibrated, some aren't. Mine doesn't even claim to be an accurate rf voltmeter, the dial being marked RELATIVE FIELD STRENGTH. This is about as unimportant as it can be. Since what we want to do is read *gain*, our readings will be a *ratio*: signal out over signal in; The meters will all do that with ease and grace. Incidentally, my Old Faithful, on its 50- $\mu\text{V}$  range, actually does read very close to 50 $\mu\text{V}$ .

With such a meter and any kind of signal generator—a pattern generator, bar-dot, or even an off-the-air TV signal—you can make fast, accurate rf-gain tests through any kind of TV tuner. The diagram (page 58) shows test points.

Most field-strength meters have both 300-ohm balanced and 75-ohm unbalanced inputs. For this kind of work, use the 75-ohm—easier. Get a piece of 75-ohm coax about 3–4 feet long. Put a connector on one end to fit your field-strength meter.

Strip about 1 inch of the shield

braid off the other end. Put a miniature alligator clip on the inner conductor. Wrap its shank and the wire with narrow strips of plastic tape to keep the solid inner conductor from breaking.

Better put an insulator over the clip, to avoid shorting things out. You can solder a small 2.2- or 3.3-pF ceramic capacitor between the end of the inner conductor and the clip to prevent loading and upsetting age, bias and input circuit impedance.

## Stage-gain tests

This testing approach is valuable for sets where the question is "Does the tuner have enough gain on a certain channel, or is the trouble something else?" So, feed an rf signal into the antenna terminals. Read the signal level there, and note the value (1). We're using a single-ended probe, but this is immaterial. Clip the end to either antenna terminal and you'll get a reading. The probe seems to work just as well without a ground lead on the coax shield.

If you're using a signal generator, you can set the output for any convenient reading, but use a small signal. If your TV antenna signal is too high, you can use a resistive pad, but this ordinarily isn't necessary. As long as we know the signal level, we can figure out the gain, and that's what we want.

Now go to the rf grid (2). You can get at it without taking the tuner apart by setting the tube up on a test adapter. (If you want to, you can put the blocking capacitor inside the body of a test prod to make it easier to handle.) Note the rf signal strength. If it is about the same as at the antenna terminals, the

antenna transformer or balun is okay.

Now check the rf plate or collector signal (3 and 4). That, divided by the grid or base signal, should give you the gain through the tube or transistor. You can check various working tuners and see what it ought to be. I tried an old tuner with a pentode amplifier. Setting the signal for a reading of 10 on the antenna, I got 8 on the rf grid and a little over 50 at the rf plate. Cascodes or nuvistors might show a higher gain.

The mixer grid (5) read 500, so the interstage rf coil was okay, too. At the mixer plate (6), still at the input frequency, I read 350, which showed that the mixer stage was okay, since the lower impedance of the i.f.-transformer primary was cutting down the higher-frequency rf signal. However, it was going through, which is all I wanted to know.

These tests took about 5 minutes. All I had to do was touch the various test points and I got the readings, bang. So, this scheme should be handy for those is-it-okay-or-isn't-it tests that we have to make so often—the rapid-elimination-of-possibilities type.

If we can be *sure* that the signal is going through the tuner, then we can go on happily digging around in the i.f. stages or age, or whatever. If it isn't getting through the tuner, then we can fix that first. Also very handy for finding balun coils with blown-out windings after a short visit from a thunderbolt.

## Oscillator tests

You can even read the tuner's oscillator signal on some channels if your FSM is the continuous-tuning type that goes from low to high TV channels

# A plug for...



Stereo Headset  
Extension Coil Cord  
"Molded-On" Stereo head  
set extension coil cord.

Three conductor phone plug one end of 15' (extended) coil cable. The other end, a 3 conductor phone jack. Retracted length 3'.



Guitar Coil Cord

Molded-On guitar coil cord. Engineered to connect guitar to amplifier. Molded-On right angle, completely shielded phone plug, one end of 20' (extended) black jacket, shielded coil cable. The other end a straight Molded-On phone plug. Retracted length is 3'. Part No. 20' RSP-RE.

## BARKER

### MOLDED-ON® PLUGS AND CONNECTORS

The World's Largest Manufacturer  
of Molded-On Cables and Connectors

The greatest name in "Molded-On" plugs and connectors is Barker—manufacturers of connecting cables for every audio, hi-fi and stereo need.

Barker plugs are solid plastic units, molded directly onto the wire ends to provide unflinching performance and unexcelled appearance. Barker has the most manufacturing experience . . . the most engineering experience.

If you are a manufacturer of—amplifiers, tuners, record changers, microphones, speaker accessories, stereo head sets or musical instruments—let Barker be your source of supply. Let us quote you! Distributors and dealers: write for our latest catalog. All our products made on our U.S.A. premises. Circle Reader's Service # for our latest catalog. For speedier service, write us direct.

### BARKER PRODUCTS CO.

344 Central St., Saugus, Mass. 01906  
Telephone: 617-233-6676

Subsidiary of  
Component Manufacturing Service, Inc.

Circle 26 on reader's service card

## SIGNAL-TRACE FM-RADIO AND TV TUNERS WITH A FIELD-STRENGTH METER

including the FM band. For instance, on channel 2, the oscillator should be working around 101 MHz (40 MHz above the station carrier frequency), and does fall in the FM band. However, if a TV station signal will go through the tuner showing gain at all stages, but we still have no picture and no sound, we would suspect a dead oscillator (provided that all other things have been checked—i.f., video etc.). Snow indicates a weak rf amplifier.

### Aligning tuners

Incidentally, if you want to touch up the alignment of a tuner, especially a turret type, without a lot of trouble, the field-strength meter is invaluable. Just hook the probe to the mixer grid or even to the mixer plate, and twiddle the rf and mixer grid coils to your heart's content. The field-strength meter will show you whether the signal is increasing or decreasing.

But you won't see the *curve shape* of course, so take it easy. You can check both the picture and the sound carriers for maximum, but equal amplitude. In the incremental inductance (wafer switch) tuners, be sure that you check the lower channels for proper alignment if you change any of the adjustments for the upper channels. Otherwise you are likely to detune one or more channels below the one you have adjusted. Procedure is the same as for oscillator adjustments.

### Sensitivity checks

Want to check a tuner quickly to see if it has enough gain? Or make an overall sensitivity check of a TV set being used in a fringe area? You need to know two things: signal in and signal out, and a "standard" value for each.

As far as I know, there is no standard for *all* TV sets, but here are some values you can use. If the set will give you a 3-volt p-p video signal at the video detector with a 50- $\mu$ V rf input, it is pretty sensitive. We can use the field-strength meter here.

Hook the scope probe to the video-

detector output or video-amplifier grid (same place). Now feed in a test rf signal from any of the sources just mentioned, with the field-strength meter connected across the antenna terminals. Set the output of the signal generator to 50- $\mu$ V and then check the p-p signal output at the video detector.

You can use an "air" signal for this. If it is too strong, you can cut it down with resistive pads. Simpler way—just reduce the signal by moving the lead-in farther from the antenna terminals while watching the field-strength meter. In other words, just loosen the coupling.

### Testing antenna boosters

Got an antenna booster on the bench that's been repaired after being zotched by lightning? Want to know whether it's working or not before you climb all the way up that tower to put it back? Hook it up on the bench, fasten an antenna to it, and read the input and output signal levels.

On a typical wideband booster with one transistor, I read 250 at the input and 3,500 at the output, indicating plenty of gain. Since practically all of the more recent models are wideband, you can check them on at least four channels to see if they're working over the whole range. Say 2 and 6, and then 7 and 12 or 13. You can check each channel if you want to take the time, but it usually isn't necessary. If the band-edge channels are okay, the booster is apt to be all right over the whole band.

Incidentally, I got a fat fooling while running these tests, and you might watch out for it. I checked a booster on channels 2 and 6 and got nice gain. Then, on the high band, less than half as much. After checking it on an air signal, and finding that it had pretty good gain on the highs, I found out what had happened.

The generator's output on the low band which was "running" on fundamentals was higher than the high band which was "working" on harmonics. Solution was to "crank" up the generator's output control to get more signal. **R-E**

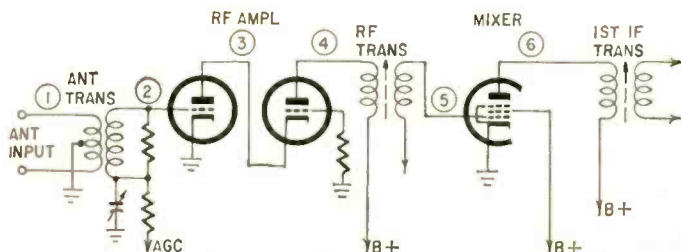

Key test points to use in tracing signal through a TV tuner with a field-strength meter.

# R-E PUZZLER

Here are more electronics braintwisters to sharpen your wits on. They should be simple unless you think "ferrous" means a large wheel ride at an amusement park, or that "tweeter" is a canary and "woofers" a dog with tonsillitis! Each word is connected to the one above and below by a single letter. Then, GO!

- |   |  |
|---|--|
| 1 A thermosensitive detector of radiant power.                  | 14 Specially designed type of speaker baffle.                            |
| 2 Having the same electric potential.                           | 15 The study of communication and control mechanisms in man and machine. |
| 3 A short tube or bushing.                                      | 16 Low-frequency video interference.                                     |
| 4 The current taken from a power source.                        | 17 Form of mechanical hysteresis or "play".                              |
| 5 An alternate path around a circuit element.                   | 18 Device for measuring force.   |
| 6 Piece of natural quartz.                                      | 19 Two triodes in same tube envelope.                                    |
| 7 Without color.  | 20 Speaker designed to reproduce high frequencies.                       |
| 8 Antenna characteristic determining orientation.               | 21 Surrounding; as of noise, temperature or pressure.                    |
| 9 Used in making high-reliability capacitors.                   | 22 The unit of magnetic flux.  |
| 10 Negative-resistance vacuum tube.                             | 23 Picture tube in television receiver.                                  |
| 11 Tough plastic compound with excellent insulating properties. | 24 An electrical protective device.                                      |
| 12 A memory-type CRT.   | 25 Emission of light which continues after excitation is removed.        |
| 13 Loss of electrical energy as heat.                           |  |

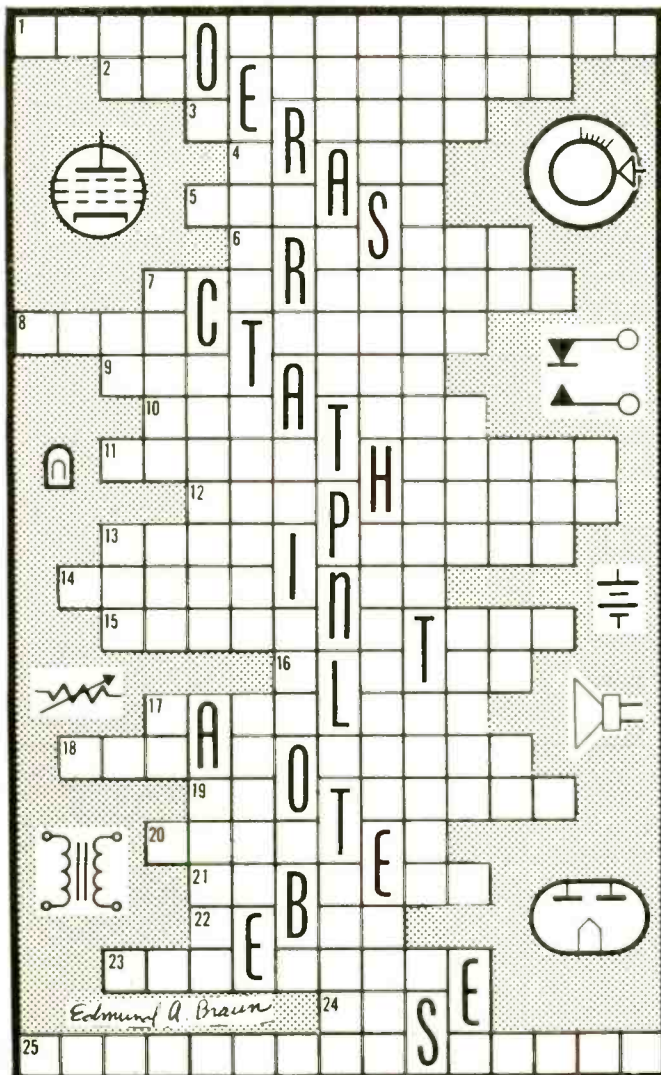

Solution next month

Forty years ago, radiomen bought this BH vacuum tube—patented by Raytheon—with complete confidence in its performance.



Today, you can buy the wide range of Raytheon receiving tubes with the same confidence. Because more than 40 years of engineering experience—with all types of electronic components and systems—go into every Raytheon receiving tube.



Ask your distributor or dealer about this Raytheon tube kit for color TV service. It packs nineteen popular types—including the widely-used 5U4—into a single low-cost kit. Look for this special buy—of reliable Raytheon receiving tubes—today.



Circle 27 on reader's service card

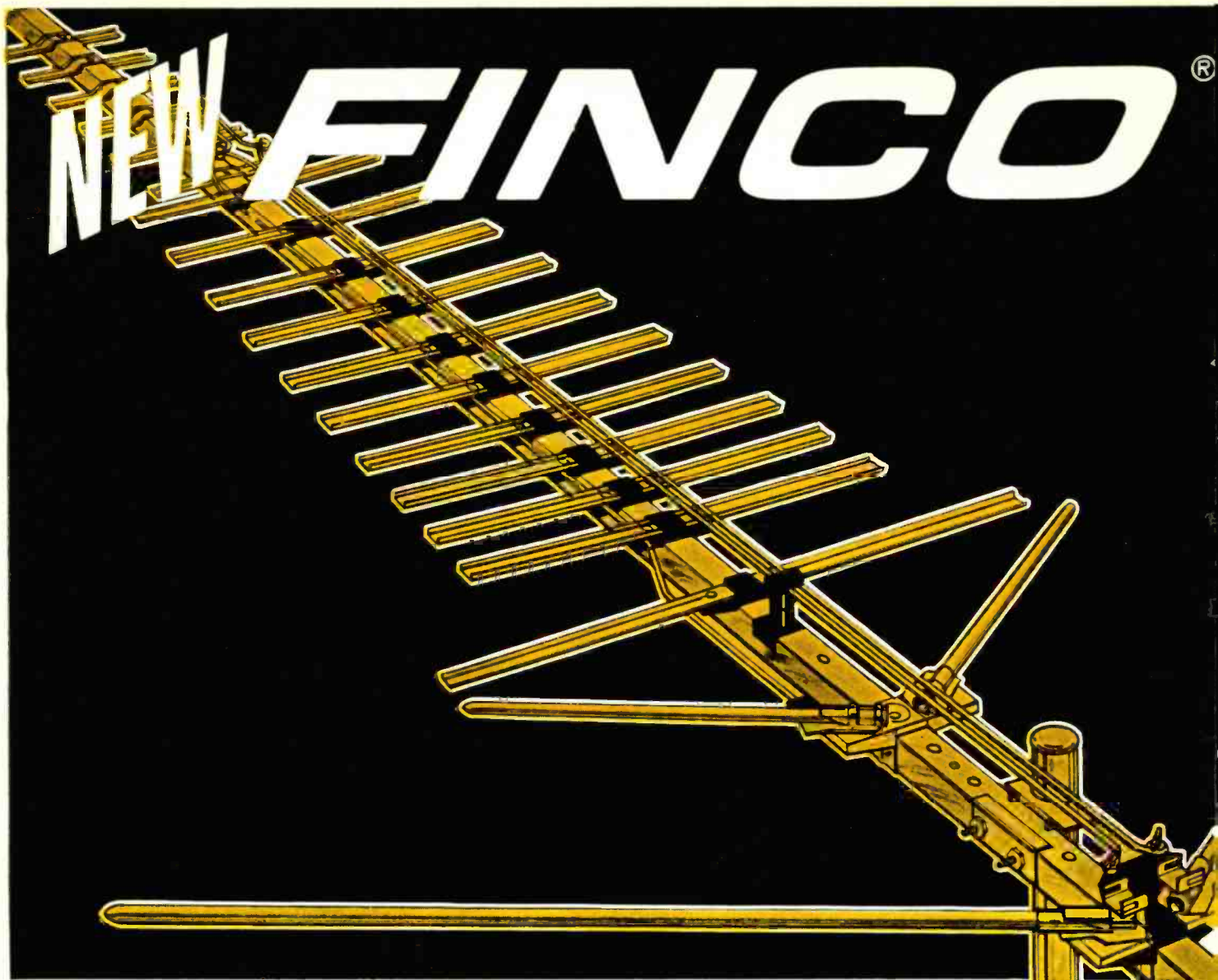

*"the ANTENNA that captures the RAINBOW"*

No two reception areas are alike in the number of stations, UHF and VHF, station channel frequencies, and signal strengths.

FINCO has developed the Color Spectrum Series of antennas — "Signal Customized" — to exactly fit the requirements of any given area. There is a model scientifically designed and engineered for every area, even the most troublesome, and for all combinations of signal conditions.

Engineering studies show that a receiving antenna should have more gain as channel frequency is increased — that is, channel 6 more than channel 2, channel 13 more than channel 7, and UHF from channel 14 on up...

- 1 — to compensate for signal strength loss
- 2 — to compensate for down-lead loss
- 3 — to meet receiver requirements for more signal to operate properly

FINCO Color Spectrum Antennas obtain this frequency dependent characteristic through a newly developed principle of spacing between elements. Gain increases as frequency increases. This new FINCO engineering break-through, combined with superior flat response patterns and unusually high front-to-back ratios, assure the finest COLOR and B & W reception possible... everywhere.



Write for full information on "Signal Customized" Antennas:

**THE FINNEY COMPANY**



















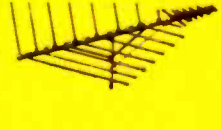



34 West Interstate Street • Dept. RE • Bedford, Ohio 44146



# COLOR SPECTRUM T.M.

## ANTENNAS are "signal customized" for better reception.

Check this chart for the FINCO "SIGNAL CUSTOMIZED" Antenna best suited for your area

STRENGTH OF UHF SIGNAL AT RECEIVING ANTENNA LOCATION	Strength of VHF Signal at Receiving Antenna Location				
	NO VHF	VHF SIGNAL STRONG	VHF SIGNAL MODERATE	VHF SIGNAL WEAK	VHF SIGNAL VERY WEAK
NO UHF 		 CS-V3 \$10.95	 CS-V5 \$17.50   CS-V7 \$24.95	 CS-V10 \$35.95	 CS-V15 \$48.50   CS-V18 \$56.50
UHF SIGNAL STRONG 	 CS-U1 \$9.95	 CS-A1 \$18.95	 CS-B1 \$29.95	 CS-C1 \$43.95	 CS-C1 \$43.95
UHF SIGNAL WEAK 	 CS-U2 \$14.95	 CS-A2 \$22.95	 CS-B3 \$49.95	 CS-C3 \$59.95	 CS-D3 \$69.95
UHF SIGNAL VERY WEAK 	 CS-U3 \$21.95	 CS-A3 \$30.95	 CS-B3 \$49.95	 CS-C3 \$59.95	 CS-D3 \$69.95

NOTE: In addition to the regular 300 ohm models (above), each model is available in a 75 ohm coaxial cable download where this type of installation is preferable. These models, designated "XCS", each come complete with a compact behind-the-set 75 ohm to 300 ohm balun-splitter to match the antenna system to the proper set terminals.

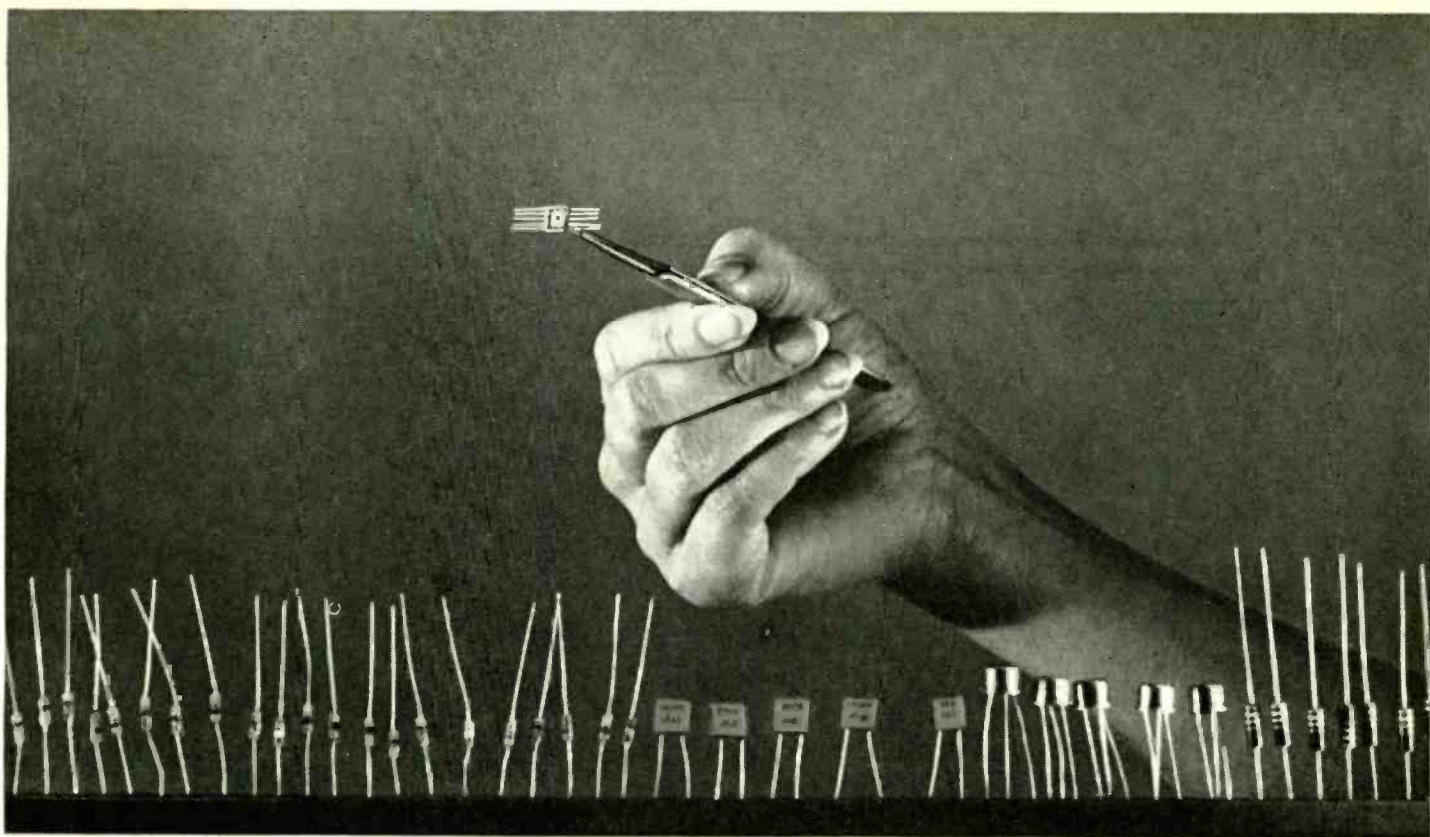

50 functions in a single chip. The functions of 50 separate transistors, diodes, resistors and capacitors can now be formed by the tiny dot in the center of the integrated circuit held by the tweezers.

# The "Chip"

## ...will it make or break your job future?

THE DEVELOPMENT OF INTEGRATED CIRCUITRY is the dawn of a new age of electronic miracles. It means that many of today's job skills soon will be no longer needed. At the same time it opens the door to thousands of exciting new job opportunities for technicians solidly grounded in electronics fundamentals. Read here what you need to know to cash in on the gigantic coming boom, and how you can learn it right at home.

**T**INY ELECTRONIC "CHIPS," each no bigger than the head of a pin, are bringing about a fantastic new Industrial Revolution. The time is near at hand when "chips" may save your life, balance your checkbook, and land a man on the moon.

Chips may also put you out of a job...or into a better one.

"One thing is certain," said *The New York Times* recently. Chips "will unalterably change our lives and the lives of our children probably far beyond recognition."

A single chip or miniature integrated circuit can

perform the function of 20 transistors, 18 resistors, and 2 capacitors. Yet it is so small that a thimbleful can hold enough circuitry for a dozen computers or a thousand radios.

### Miniature Miracles of Today and Tomorrow

Already, as a result, a two-way radio can now be fitted inside a signet ring. A complete hearing aid can be worn entirely inside the ear. There is a new desk-top computer, no bigger than a typewriter yet capable of 166,000 operations per second. And it is almost possible to put the entire circuitry of a color television set inside a man's wrist-watch case.

And this is only the beginning!

Soon kitchen computers may keep the housewife's refrigerator stocked, her menus planned, and her calories counted. Her vacuum cleaner may creep out at night and vacuum the floor all by itself.

Money may become obsolete. Instead you will simply carry an electronic charge account card. Your employer will credit your account after each week's work and merchants will charge each of your purchases against it.

When your telephone rings and nobody's home, your call will automatically be switched to the phone where you can be reached.

Doctors will be able to examine you internally by watching a TV screen while a pill-size camera passes through your digestive tract.

### New Opportunities for Trained Men

What does all this mean to someone working in electronics who never went beyond high school? It means the opportunity of a lifetime—if you take advantage of it.

It's true that the "chip" may make a lot of manual skills no longer necessary.

But at the same time the booming sales of articles and equipment using integrated circuitry has created a tremendous demand for trained electronics personnel to help design, manufacture, test, operate, and service all these marvels.

There simply aren't enough college-trained engineers to go around. So men with a high school education who have mastered the fundamentals of electronics theory are being begged to accept really interesting, high-pay jobs as engineering aides, junior engineers, and field engineers.

### How To Get The Training You Need

You can get the up-to-date training in electronics fundamentals that you need through a carefully chosen home study course. In fact, some authorities feel that a home study course is the best way. "By its very nature," stated one electronics publication recently, "home study develops your ability to analyze and extract information as well as to strengthen your sense of responsibility and initiative." These are qualities every employer is always looking for.

If you do decide to advance your career through spare-time study at home, it makes sense to pick an electronics school that specializes in the home study method. Electronics is complicated enough without trying to learn it from texts and lessons that were designed for the classroom instead of correspondence training.

The Cleveland Institute of Electronics has everything you're looking for. We teach only electronics—no other subjects. And our courses are designed especially for home study. We have spent over 30 years perfecting techniques that make learning electronics at home easy, even for those who previously had trouble studying.

Your instructor gives you assignments his undivided personal attention—it's like being the only student in his "class." He not only grades your work, he analyzes it. And he mails back his corrections and comments the same day he gets your lessons, so you read his notations while everything is still fresh in your mind.

### Always Up-To-Date

Because of rapid developments in electronics, CIE courses are constantly being revised. Students re-

#### ENROLL UNDER NEW G.I. BILL

All CIE courses are available under the new G.I. Bill. If you served on active duty since January 31, 1955, or are in service now, check box on reply card for G.I. Bill information.

**Tiny TV camera** for space and military use is one of the miracles of integrated circuitry. This one weighs 27 ounces, uses a one-inch vidicon camera tube, and requires only four watts of power.



ceive the most recent revised material as they progress through their course. This year, for example, CIE students are receiving exclusive up-to-the-minute lessons in Microminiaturization, Logical Troubleshooting, Laser Theory and Application, Single Sideband Techniques, Pulse Theory and Application, and Boolean Algebra. For this reason CIE courses are invaluable not only to newcomers in Electronics but also for "old timers" who need a refresher course in current developments.

### Praised by Students Who've Compared

Students who have taken other courses often comment on how much more they learn from CIE. Mark E. Newland of Santa Maria, California, recently wrote: "Of 11 different correspondence courses I've taken, CIE's was the best prepared, most interesting, and easiest to understand. I passed my 1st Class FCC exam after completing my course, and have increased my earnings \$120 a month!"

### Get FCC License or Money Back

No matter what kind of job you want in electronics, you ought to have your Government FCC License. It's accepted everywhere as proof of your education in electronics. And no wonder—the Government licensing exam is tough. So tough, in fact, that without CIE training, two out of every three men who take the exam fail.

But better than 9 out of every 10 CIE-trained men who take the exam pass it.

This has made it possible to back our FCC License courses with this famous Warranty: you *must* pass your FCC exam upon completion of the course or your tuition is refunded in full.

### Mail Card For Two Free Books

Want to know more? The postpaid reply card bound in here will bring you a free copy of our school catalog describing today's opportunities in electronics, our teaching methods, and our courses, together with our special booklet on how to get a commercial FCC License. If card has been removed, just send us your name and address.

  
**CIE**  
**Cleveland Institute of Electronics**  
1776 E. 17th St., Dept. RE-40, Cleveland, Ohio 44114

Accredited Member National Home Study Council  
A Leader in Electronics Training... Since 1934



**SONY®**

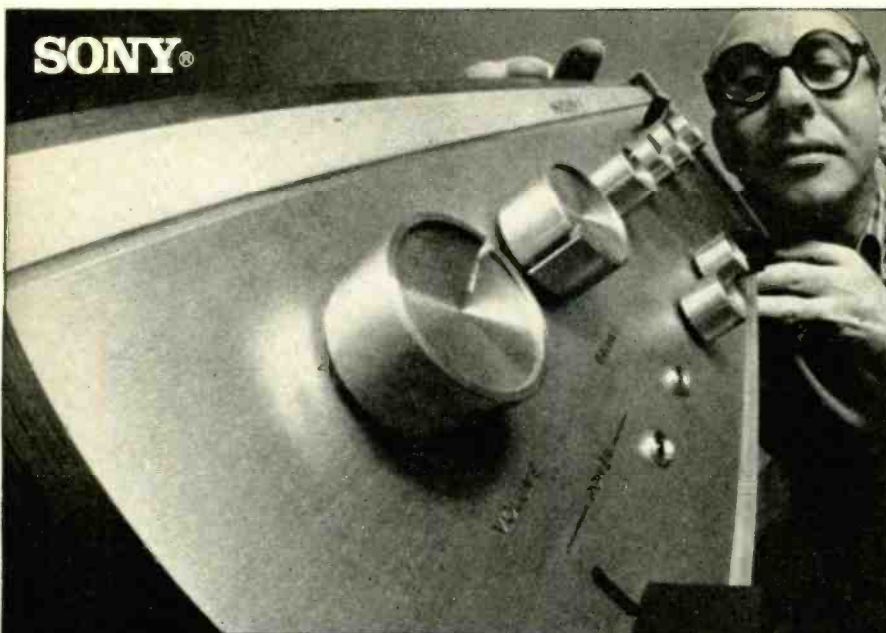

## Building our own transistors has its advantages... Listen.

The new TA-1080 employs 30 Sony silicon transistors, some built specially for this integrated stereo amplifier.

The TA-1080, modestly-powered heir to the highly-regarded Sony TA-1120, delivers 90 watts IHF power to 8 ohms, both channels operating. Distortion is virtually non-existent at all power levels—less than 0.1% at 1/2 watt and 0.15 at rated output. Overall

frequency response is flat from 30 to 100,000 Hz (+0 db/-2 db). Damping factor and signal-to-noise ratio are excellent. The control facilities are everything you'd expect from the most deluxe units.

The TA-1080, \$299.50 (suggested list). Hear it at your high fidelity dealer. Sony Corp. of America, Dept. H., 47-47 Van Dam St., L.I.C., N.Y. 11101.

Circle 36 on reader's service card

*Now... the most enjoyable, most rewarding electronic kit project of your life*



**a Schober Electronic Organ!**

The Schober Organ Corporation  
42 West 61st Street, New York, N. Y. 10025

HAD YOUR FILL of amplifier kits, receiver kits, meter kits, all the conventional kits? Then go to work on the biggest, most fascinating kit of them all—and end up with a finer musical instrument than you could buy for twice the price. The Schober Theatre Organ at left, for example, plus Schober's self-teaching music courses, lets you *participate* in music, not just listen to it. This is one electronic project the wife and kids will encourage—because it's for them, too! It contains the best components available—thousands of them—plus the kind of unmistakable, step-by-step instructions you've dreamed of and Schober is famous for.

The Theatre Organ (left) costs just \$1550 if you use your own amplifier and speaker system, and you can pay as you build to spread out the cost. There are three other Schober Organ models, too, starting at \$645. Each one includes every bit and piece you need, including a magnificent walnut console—unless you want to build your own woodwork and save even more. And each model has the kind of pipelike tonal variety you don't often find in electronic organs. The free Schober color catalog has lots of pictures and data; and for 25¢ we'll send you 72 pages of schematics and tech specs so you can see just what you're buying.

**FREE INFORMATION AND DEMONSTRATION RECORDING**  
Send today for your free copy of Schober's 16-page, full color booklet, plus 7" free recording.

The Schober Organ Corp., Dept. RE-51  
43 West 61st Street, New York, N. Y. 10023

Please send me Schober Organ Catalog and free 7-inch "sample" record.

Enclosed please find \$1.00 for 12-inch L.P. record of Schober Organ music.

Enclosed is 25¢ for schematics and tech specs.

NAME .....

ADDRESS .....

CITY..... STATE..... ZIP NO.....

Circle 30 on reader's service card

# NEW BOOKS

**JUNCTION TRANSISTORS**, by John J. Sparks. Pergamon Press, Inc., 44-01 21 St., Long Island City, New York 11101. 5 x 8 in., 356 pp. Paper, \$3.95

Generally mathematical in treatment, but practical and easy to read. Covers the subject thoroughly from the most fundamental junction principles through structures and special behavior. Aimed at the college engineering student.

**COMMUNICATIONS ELECTRONICS CIRCUITS**, by J. J. DeFrance. Holt, Rinehart & Winston, Inc., 383 Madison Ave., New York, N. Y. 6 1/2 x 9 1/4 in., 564 pp. Cloth, \$9.50

Written for the engineering technician, in textbook form. Examples, solved right with the problem, are scattered throughout the book. The teaching method is to illustrate by example whenever a particularly difficult topic is covered. The mathematics reach generally into advanced trigonometry, but almost never get in the way of understanding. Apparently designed for college use, the text could be understood by any high-school graduate who approaches it with a little determination. The end of each chapter brings a really generous supply of review questions, followed by plenty of problems designed to test your understanding of the material in the chapter; but, alas, no answers. Pretty well indexed.

**FLUID AMPLIFIERS**, by Joseph M. Kirshner. McGraw-Hill Book Co., 330 W. 42 St., New York, N. Y. 6 x 9 in., 296 pp. Cloth, \$16.50

An advanced book on an increasingly popular subject. Actually, the science of fluidics has many analogies in electronic circuit theory. Chapter titles can give you a clue to the range of similarities: Thermodynamics, Fluid Equations, Flow Through Passages, One Dimensional Flow, Vortex Motion, Fluid Theory, Bistable Amplifiers, Beam Deflection, Noise in Fluid Amplifiers, Characteristic Curves and Staging. Heavily mathematical in approach. Reads fairly dry (no pun intended) but covers its topic very thoroughly.

**ENGINEERS' RELAY HANDBOOK**. Hayden Books Inc., 116 W. 14 St., New York, N. Y. 10011. 7 1/2 x 10 1/2 in., 300 pp. Cloth, \$11.95

A highly specialized book, sponsored by the National Association of Relay Manufacturers. An exhaustive analysis of almost every imaginable facet of relays. Terminology, classes of service, operation principles, applications, reliability, and testing. Even has a chapter on how to specify what relay you want. Includes Government specifications. 45 packed pages of appendices add to the book's usefulness. Further, however, there is an extensive bibliography on relays, broken into topic categories. Thoroughly indexed. If there is anything you want to know about relays, you should be able to find it in this book. **R-E**

## EQUIPMENT REPORT

### EICO 711 Receiver

Circle 24 on reader's service card



THIS IS A GOOD kit for an electronics beginner to assemble. It goes together easily and, when you're finished, you'll be fascinated at the short-wave stations you can hear. The kit is also inexpensive.

It took me about 17 hours to unpack, wire, assemble and align the 711. I found no problems in assembly. The circuit is the bare minimum—4 tubes and a pair of solid-state diodes as B+ rectifiers. Still, the coils seem reasonably efficient and receiver sensitivity and selectivity are creditable. The main tuning capacitor uses split gears for anti-backlash tuning, and a separate bandspread capacitor works on all four bands, from broadcast through 30 MHz. Both dial cords were easy to string—a welcome feature!

The assembly and operating manuals assume that the builder has little or no electronics knowledge. This is a good thing, and I doubt that an electronics newcomer would have much difficulty following instructions. Eico has even listed the hand tools required for kit assembly.

You'll want to borrow an rf generator to align the Space Ranger. The process isn't difficult, but it's necessary to get maximum performance.

Despite the low cost and simple circuitry, the 711 has a noise limiter, a Q-multiplier input, an S-meter, a standby mode and a ferrite loop antenna for the broadcast band. You'll need an external antenna for short wave, and Eico has included instructions on how to make up one. They've also listed countries from which you can reasonably expect to get short-wave reception at various times.

I found the Space Ranger simple to assemble and fun to use. It has renewed my neglected interest in SW listening. Surprising what a broader picture you get of world affairs with a short-wave receiver.

—Thomas R. Haskett

Price: \$49.95 kit, \$69.95 wired

OCTOBER 1967

67

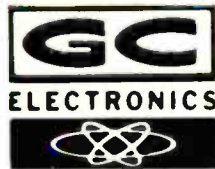

has  
everything  
in

# phono drives

Look to GC-Walsco for the largest, most versatile "one source" selection of quality parts to meet any phono drive service need.

Choose from idler and drive wheels, pressure rollers, turret drives, pulleys, fabric belts, flat and round rubber belts . . . all made to precise original equipment specifications from the finest materials available assuring you and your customers of top performance, maximum service life.

All parts are available individually, or in convenient pre-packed assortments, together with handy cross-reference Walsco wall charts to facilitate your selection.

Specify GC-Walsco . . . and you get the finest!

Write for your Giant FREE GC Catalog today . . . over 12,000 items including TV Hardware, Phono Drives, Chemicals, Alignment Tools, Audio, Hi-Fi, Stereo & Tape Recorder Accessories, Nuts & Bolts, Plugs & Jacks, Service Aids, and Resistive Devices.

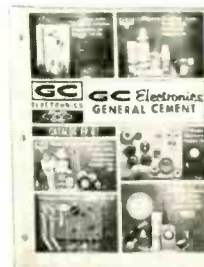

*only GC gives you  
everything in electronics.  
..... for almost 40 years!*

## GC ELECTRONICS COMPANY

400 South Wyman Street  
Rockford, Illinois 61101  
A DIVISION OF HYDROMETALS, INC.

Circle 31 on reader's service card



Phono Drive Assortment Kit  
Cat. No. 1408-02



2" O.D. Idler Wheel  
Cat. No. 1432-S

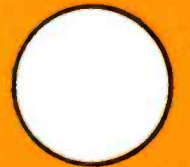

Round Rubber Belt  
Cat. No. 1410-54



Turret Drives  
Cat. No. 1465  
Cat. No. 1466  
Cat. No. 1467



Fabric Drive Belt  
Cat. No. 1409-04



Idler Pulley  
Cat. No. 1453



# ALLIED NEW 1968 CATALOG & BUYING GUIDE FREE

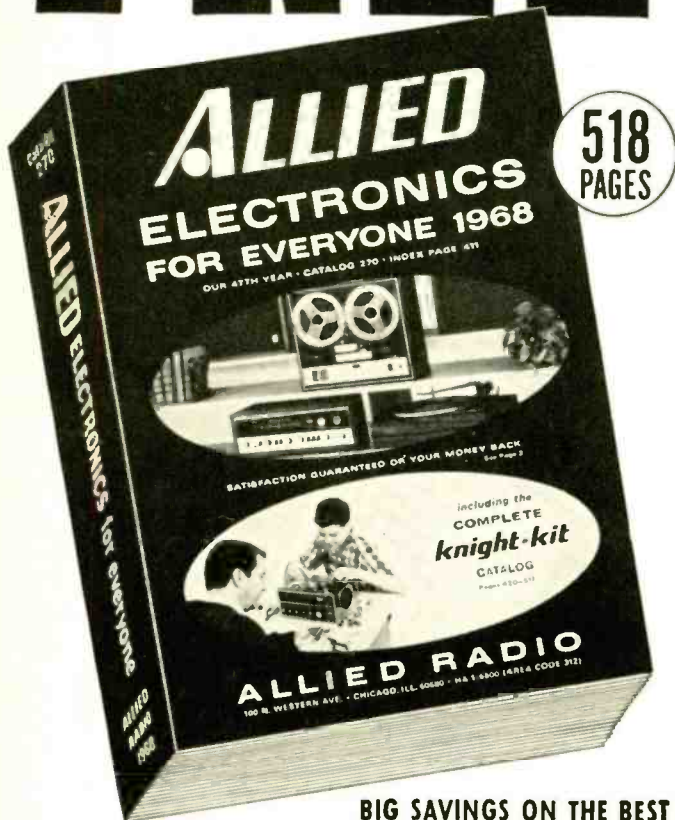

## BIG SAVINGS ON THE BEST IN ELECTRONICS FOR EVERYONE

Here it is! The world's most famous catalog of electronic equipment featuring hundreds of new and exclusive items and special Allied values.

518 pages—including the complete Knight-Kit Catalog—picturing, describing, and pricing thousands of items. The most complete inventory ever assembled of Hi-Fi, Radios, Tape Recorders, CB, Electronic Equipment, Parts and Tools... all at money-saving low prices.

NO MONEY DOWN • UP TO 2 YEARS TO PAY!

- Stereo Hi-Fi
- Famous Knight-Kits®
- Tape Recorders & Tape
- CB 2-Way Radios
- Walkie-Talkies
- FM-AM & AM Radios
- Shortwave Receivers
- Portable TV
- Phonographs
- Amateur Equipment
- Intercoms & PA
- Automotive Electronics
- Test Instruments
- TV Antennas & Tubes
- Power Tools, Hardware
- Tubes, Transistors
- Parts, Batteries, Books

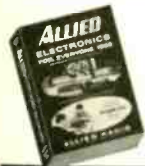

WRITE  
FOR YOUR  
COPY TODAY!

ALLIED RADIO, Dept. 2K  
P.O. Box 4398, Chicago, Illinois 60680

Send me your free catalog for 1968

NAME  Please Print

ADDRESS

CITY

STATE  ZIP CODE

Circle 32 on reader's service card

## BUILD 22 MEGOHM FET DC VOLTMETER

continued from page 45

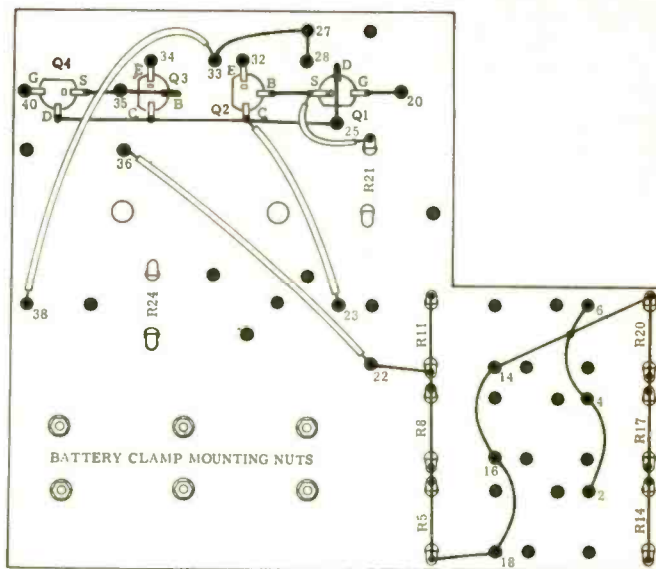

Fig. 4—Wiring on back of board is simple and not critical.

holes. Mount the trimmer potentiometers, resistors, transistor sockets and battery holders as shown in Fig. 3. Insert each trimmer's housing tabs through the holes in the board and carefully bend the tabs down. The arm of the potentiometer is electrically connected to the case.

If terminal lugs are used to connect the meter to R24 and the rest of the circuit, be sure that they are properly aligned with the  $\frac{3}{32}$ " holes in the board. Wire the underside of the board as shown in Fig. 4.

Set the board aside for the time being and prepare the panel on the meter case as shown in Fig. 5. Work slowly and carefully to avoid a sloppy job and possible breakage. Check the hole sizes to see that they conform to the meter and the other hardware.

Prewire the resistors and hookup wire on switch S2, as shown in Figs. 6 and 7, before mounting it on the panel.

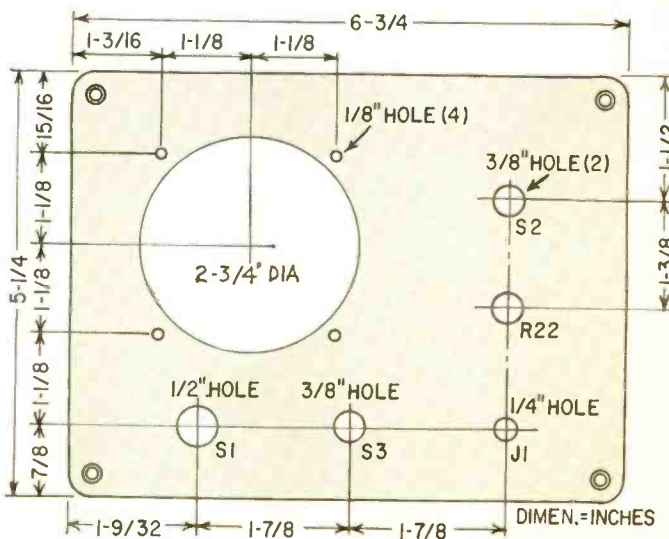

Fig. 5—Dimensions of panel can be changed to suit your parts.

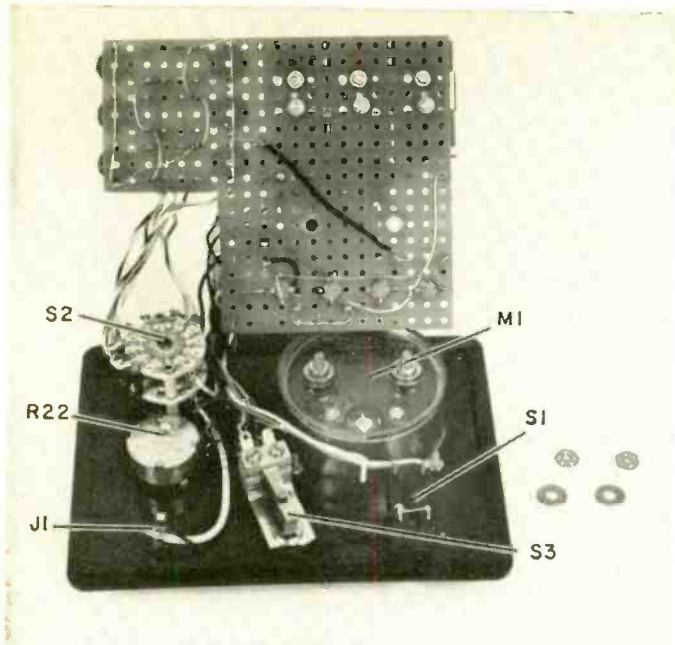

Fig. 6—Board mounts on meter terminals. Use long enough leads from S2 to permit board removal without any disconnections.

Once you have everything on the front panel, position the board on the meter and finish the wiring as shown in Fig. 8. When you finish, check your work carefully. The nuts on the meter terminals hold the board in place.

Because of the high input impedance, a shielded test-probe lead is a must. A pair of miniature alligator clips can be used on the business end of the probe, and a miniature phone jack to mate with J1 can be placed on the other end.

### Calibration

As supplied, the meter scale is marked from 0 to 10, which is fine for the 1-, 10- and 100-volt ranges. For the 0.3-, 3-, 30- and 300-volt ranges, you will find it convenient to mark the dial linearly from 0 to 30.

Almost any voltmeter calibration technique will do. It is simply a case of adjusting a potentiometer to obtain a proper reading for a known test voltage. You can use a variable dc power supply and a conventional vom. Simply connect the vom and the FET-VM across the supply. Switch the FET-VM to the 300-volt range and adjust the voltage supply to 300 volts as read on the vom. Then adjust R20 for full-scale deflection of the FET-VM. Repeat this process for each range, using appropriate voltages, of course.

If you don't have a variable power supply, a few batteries will do the job, as shown in Fig. 9. If you use a 90-volt source for calibration of the 300-volt range, you'll have to adjust R20 for a 90-volt reading.

Before adjusting for full-scale readings, however, set

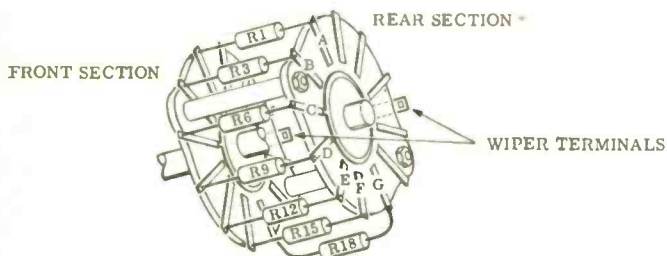

Fig. 7—Resistors can be prewired on the range switch. Letters on rear section of switch correspond to those shown in Fig. 8.

# Weller®

...the soldering tools professionals depend on



### The original Dual Heat Soldering Guns

Preferred by technicians for their fast heating copper tips, exclusive trigger-controlled dual heat, and high soldering efficiency. Available in 3 watt-age sizes, each with spotlight.

100/140-watt Model 8200, 145/210-watt Model D-440, and 240/325-watt Model D-550. Also in complete kits:

- Model 8200PK includes 100/140 watt gun, extra tips, tip-changing wrench, flux brush, soldering aid and solder
- Model D-550PK heavy-duty 240/325 watt gun kit with soldering, cutting and smoothing tips, wrench and solder

### Dependable MARKSMAN Irons in a size for every job



Ideal for deep chassis work and continuous-duty soldering, Marksmann irons outperform others of comparable size and weight. All five feature long-reach stainless steel barrels and replaceable tips.

- 25-watt, 1 3/4-oz. Model SP-23 with 1/8" tip (In kit with extra tips, soldering aid, solder—Model SP-23K)
- 40-watt, 2-oz. Model SP-40 with 1/4" tip
- 80-watt, 4-oz. Model SP-80 with 3/8" tip
- 120-watt, 10-oz. Model SP-120 with 1/2" tip
- 175-watt, 16-oz. Model SP-175 with 5/8" tip

### NOW a BATTERY OPERATED IRON for field servicing

Use this lightweight service tool for automotive wiring, model planes, or mobile communications. Works from any 12 volt battery or 12-14 volt AC/DC supply. Supplied complete with long-life patented "Temperature Sensing" tip, 12-ft. power cord and terminal clips. Model TCP-12—12 volt; Model TCP-24—24-28 volts.



Complete Weller Line includes replacement tips and solder at your Electronic Parts Distributor

**WELLER ELECTRIC CORPORATION, Easton, Pa.**  
WORLD LEADER IN SOLDERING TECHNOLOGY

# FREE!



## BRAND NEW EDITION FALL AND WINTER RADIO-TV ELECTRONICS CATALOG



THE WORLD'S MOST  
FAMOUS CATALOG OF  
ELECTRONIC EQUIPMENT!

YOUR BUYING GUIDE FOR:  
• Stereo & Hi-Fi Systems & Components • Tape Recorders • Electronic Parts, Tubes, Tools • Phonos & Records • Ham Gear • Test Instruments & Kits • Cameras & Film • PA • Citizens-Band • Radio & TV Sets • Musical Instruments

SEND FOR YOURS TODAY!

MAIL TODAY TO:

**BURSTEIN-APPLEBEE**

Dept. REJ, 1012 McGee, Kansas City, Mo. 64106

Name \_\_\_\_\_

Address \_\_\_\_\_

City \_\_\_\_\_ State \_\_\_\_\_ Zip Code \_\_\_\_\_

DO YOUR FRIEND A FAVOR... ALSO INCLUDE HIS NAME AND ADDRESS IN ENVELOPE WHEN MAILING YOUR REQUEST

Circle 35 on reader's service card

# EIGHT INSTRUMENTS IN ONE

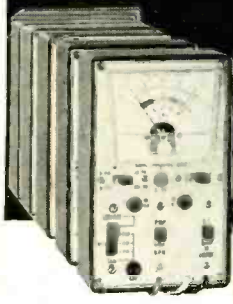

- Out-of-Circuit Transistor Analyzer
- Dynamic In-Circuit Transistor & Radio Tester
- Signal Generator
- Signal Tracer • Voltmeter
- Milliammeter
- Battery Tester
- Diode Checker

## Transistor Analyzer Model 212

Factory Wired & Tested — \$19.50  
Easy-to-Assemble Kit — \$13.50

YOU DON'T NEED A BENCH FULL OF EQUIPMENT TO TEST TRANSISTOR RADIOS! All the facilities you need to check the transistors themselves — and the radios or other circuits in which they are used — have been ingeniously engineered into the compact, 6-inch high case of the Model 212. It's the transistor radio troubleshooter with all the features found only in more expensive units. Find defective transistors and circuit troubles speedily with a single, streamlined instrument instead of an elaborate hook-up.

### Features:

Checks all transistor types — high or low power. Checks DC current gain (beta) to 200 in 3 ranges. Checks leakage. Universal test socket accepts different base configurations. Identifies unknown transistors as NPN or PNP.

Dynamic test for all transistors as signal amplifiers (oscillator check), in or out of circuit. Develops test signal for AF, IF, or RF circuits. Signal traces all circuits. Checks condition of diodes. Measures battery or other transistor-circuit power-supply voltages on 12-volt scale. No external power source needed. Measures circuit drain or other DC currents to 80 milliamperes. Supplied with three external leads for in-circuit testing and a pair of test leads for measuring voltage and current. Comes complete with instruction manual and transistor listing.

EMC, 625 Broadway, New York 12, N. Y.

Send me FREE catalog of the complete value-packed EMC line, and name of local distributor.

NAME \_\_\_\_\_ RE-10

ADDRESS \_\_\_\_\_

CITY \_\_\_\_\_ ZONE \_\_\_\_\_ STATE \_\_\_\_\_

# EMC

ELECTRONIC MEASUREMENTS CORP.  
625 Broadway, New York 12, New York

Export: Pan-Mar Corp., 1270 B'way, N. Y. 1

## BUILD 22 MEGOHM FET DC VOLTMETER

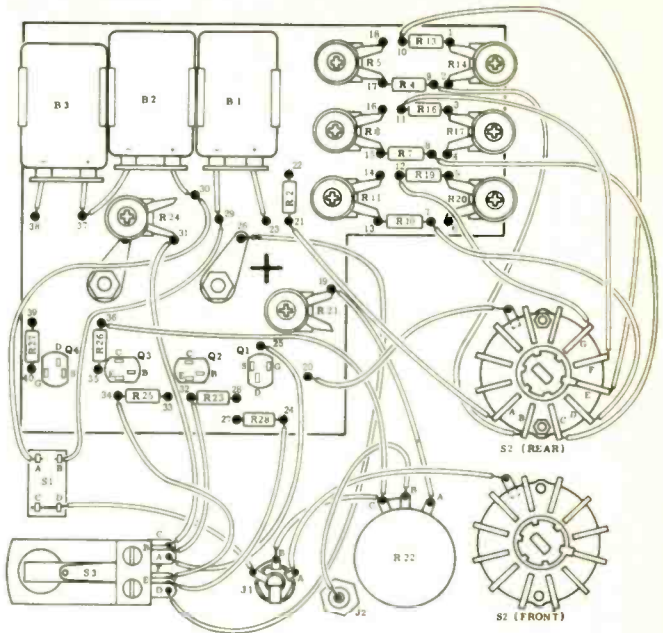

Fig. 8—Final wiring diagram. Note position of positive terminal on meter. Double check your meter for similar polarity.

R21 and R22 for a zero reading when no test voltage is applied. Be sure to short the input leads to avoid stray pickup. Resistor R21 should be set so that the meter zeros when R22 is set at the middle of its range.

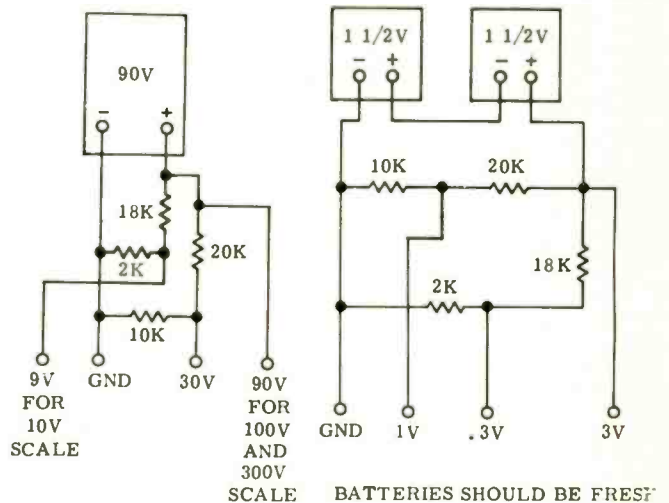

Fig. 9—Simple circuits needed to calibrate the voltmeter

### Operation

Whenever you use the FET voltmeter, try the battery-test pushbutton first. If the meter indicates above the mid-scale point, the batteries are okay.

After you turn the instrument on, allow a few minutes for the circuit to stabilize. Check the ZERO ADJ control (probe shorted). You can disregard any meter indication when the probe is not shorted or connected to anything. Due to the 22-megohm input impedance, the voltmeter is subject to some stray pickup—especially on the 0.3-vol range. To be safe, as when working with any voltmeter, start with the range switch on the highest range, then switch to a lower range until you get a usable meter deflection. R-E



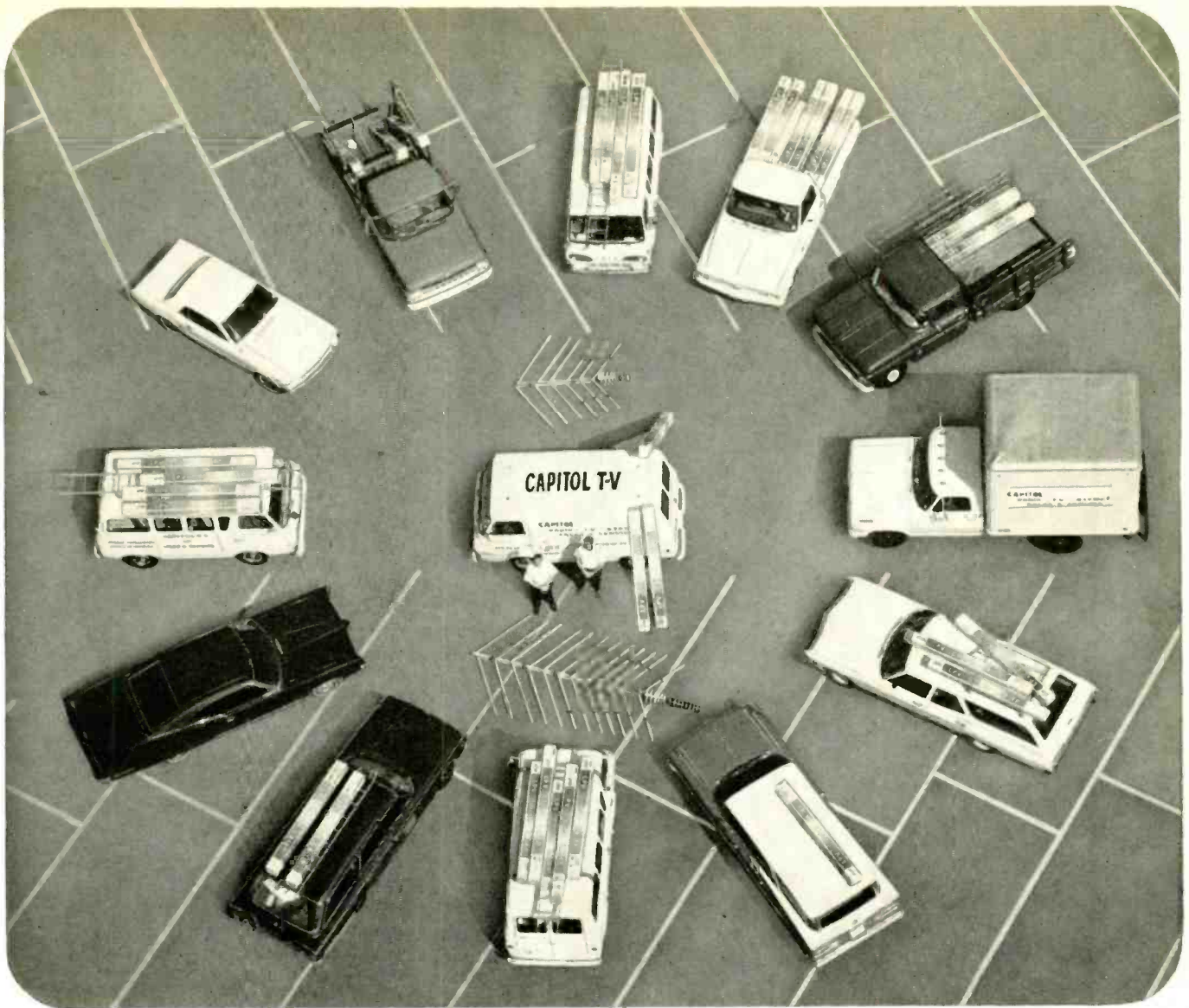

## "When you guarantee finer color pictures...

...like we do, you *better* deliver!" says George Comer and Bob Garrison, of Capitol TV Sales and Service, Atlanta, Georgia.

"We install antennas for many dealers, retailers, chains and department stores here in the Atlanta area. They look to us to give their customers the fine color reception their customers were guaranteed when they bought their sets. We make sure we deliver the best possible color pictures by installing JFD Color Lasers.

"Before using Color Lasers, we installed VHF LPV Log Periodics. Frankly, we didn't think a combination 82-channel antenna would work so well across the VHF, UHF and FM bands. But the Color Laser is proving it to us where it counts — in happy customers and protected profits."

George Comer and Bob Garrison know from experience—like other professionals

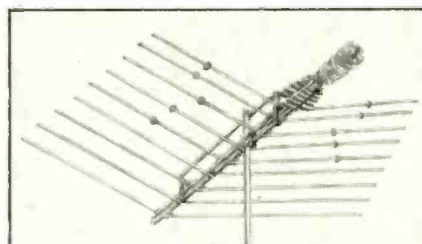

— that JFD Color Lasers come through with the superb reception people expect from a professional service company.

Only Color Lasers offer:

**BRILLIANT COLOR** — flat (frequency independent) response across each channel, free from suck-outs or roll-off. Keeps colors vivid and alive.

**PATENTED W-I-D-E BAND LOG PERIODIC DESIGN** — the most efficient ever developed — provides higher gain, better

signal-to-noise ratios, needle-sharp directivity. Eleven patents cover its revolutionary space-age design.

**MORE DRIVEN ELEMENTS.** Harmonically resonant capacitor coupled design makes dual-function elements work on both VHF and UHF frequencies. *Entire* antenna (not just part of it as in other log periodic imitations) responds on every channel.

**LUSTROUS, ELECTRICALLY CONDUCTIVE GOLD ALODIZING** promotes signal transfer, protects against corrosion, enhances appearance.

*The Best Antenna for Color TV is The Color Laser by*

# JFD®

Now at your JFD distributor!

**JFD ELECTRONICS CO.** 15th Avenue at 62nd Street, Brooklyn, N.Y. 11219

JFD International, 64-14 Woodside Ave., Woodside, N.Y. 11377 JFD Canada, Ltd., Ontario, Canada  
JFD de Venezuela, S.A., Avenida Los Haticos 125-97, Maracaibo, Venezuela

LICENSED UNDER ONE OR MORE OF U.S. PATENTS 2,958,061; 2,985,879; 3,011,168; 3,108,280; 3,150,376; 3,210,767; RE. 25,730 AND ADDITIONAL PATENTS PENDING IN U.S.A. AND CANADA; PRODUCED BY JFD ELECTRONICS CO. UNDER EXCLUSIVE LICENSE FROM THE UNIVERSITY OF ILLINOIS FOUNDATION. LICENSED UNDER ONE OR MORE OF U.S. PATENTS 2,955,287 AND 3,015,821 AND ADDITIONAL PATENTS PENDING.

Circle 37 on reader's service card

## RADIO-ELECTRONICS READER'S SERVICE

Here's how you can get manufacturers' literature fast:

1. Tear out the post card on the facing page. Clearly print or type your name and address.

**Include zip code! Manufacturers will not guarantee to fill your requests unless your zip code is on the reader service card!**

2. Circle the number on the card that corresponds to the number appearing at the bottom of the **New Products, New Literature or Equipment Report** in which you are interested.

For literature on products advertised in this issue, circle the number on the card that corresponds to the number appearing at the bottom of the advertisement in which you are interested. Use the convenient index below to locate quickly a particular advertisement.

3. Mail the card to us (no postage required in U.S.A.)

**Advertisements in this issue offering free literature (see the advertisements for products being advertised):**

ALLIED RADIO CORP. (Pg. 68)	Circle 32
ARROW FASTENER CO., INC. (Pg. 79)	Circle 112
ARTISAN ORGANS (Pg. 78)	Circle 108
BARKER PRODUCTS CO. (Audio Division of Component Manufacturing Service, Inc.) (Pg. 58)	Circle 26
BLONDER-TONGUE (Pg. 4)	Circle 10
BROOKS RADIO & TV CORP. (Pg. 84-85)	Circle 121
BURSTEIN-APPLEBEE CO. (Pg. 70)	Circle 35
CASTLE TV TUNER SERVICE, INC. (Pg. 78)	Circle 109
CLEVELAND INSTITUTE OF ELECTRONICS (Pg. 13)	Circle 15
CLEVELAND INSTITUTE OF ELECTRONICS (Pg. 62-65)	Circle 29
CORNELL ELECTRONICS CO. (Pg. 97)	Circle 142
DATAK CORP. (Pg. 95)	Circle 131
DELTA PRODUCTS, INC. (Pg. 80)	Circle 115
DELWYN (Pg. 90)	Circle 124
DE VRY INSTITUTE OF TECHNOLOGY (A Subsidiary of Bell & Howell) (Pg. 5)	Circle 11
EDMUND SCIENTIFIC CORP. (Pg. 98)	Circle 145
EICO ELECTRONIC INSTRUMENT CO., INC. (Third Cover)	Circle 149
ELECTRO-VOICE, INC. (Pg. 23)	Circle 20
ELPA MARKETING INDUSTRIES, INC. (Pg. 93)	Circle 127
FINNEY CO. (Pg. 60-61)	Circle 28
GARRARD (British Industries Corp.) (Pg. 2)	Circle 9
GC ELECTRONICS CO. (Pg. 67)	Circle 31

HEALD ENGINEERING COLLEGE (Pg. 93)	Circle 128
HEATH COMPANY (Pg. 86-89, 91)	Circle 123
HICKOK ELECTRICAL INSTRUMENT CO. (Pg. 22)	Circle 19
INTERNATIONAL CRYSTAL MFG. CO., INC. (Pg. 100)	Circle 148
JERROLD ELECTRONICS CORP. (Distributor Sales Division) (Pg. 27)	Circle 23
JFD ELECTRONICS CORP. (Pg. 71)	Circle 37
JUDSON RESEARCH AND MFG. CO. (Pg. 94)	Circle 129
LAFAYETTE RADIO ELECTRONICS (Pg. 82)	Circle 117
MALLORY DISTRIBUTOR PRODUCTS CO. (Div. of P. R. Mallory & Co., Inc.) (Pg. 7)	Circle 13
MIKE QUINN ELECTRONICS (Pg. 95)	Circle 132
MULTICORE SALES CORP. (Pg. 84)	Circle 120
MUSIC ASSOCIATED (Pg. 78)	Circle 111
OLSON ELECTRONICS, INC. (Pg. 79)	Circle 113
OXFORD TRANSDUCER COMPANY (A Division of Oxford Electric Corp.) (Pg. 6)	Circle 12
PERMA-POWER CO. (Pg. 81)	Circle 116
PERMOFLUX CORP. (Pg. 78)	Circle 110
POLY PAKS (Pg. 98, 99)	Circle 144
RAYTHEON (Pg. 59)	Circle 27
RYE INDUSTRIES, INC. (Pg. 83)	Circle 118
SAMS & CO., INC., HOWARD W. (Pg. 76)	Circle 107
SCHOBER ORGAN CORP., INC. (Pg. 66)	Circle 30
SCOTT, INC., H. H. (Pg. 79)	Circle 100
SENCORE (Pg. 14-15)	Circle 16
SHURE BROS. (Pg. 17)	Circle 17
SOLID STATE SALES (Pg. 96)	Circle 141
SONOTONE CORP. (Electronic Applications Div.) (Pg. 75)	Circle 106
SONY CORP. OF AMERICA (Pg. 66)	Circle 36
SPRAGUE PRODUCTS COMPANY (Pg. 26)	Circle 22
SURPLUS CENTER (Pg. 94)	Circle 130
TECHPRESS, INC. (Pg. 83)	Circle 119
TRIPLETT ELECTRICAL INSTRUMENT COMPANY (Second Cover)	Circle 7
TURNER MICROPHONE CO., THE (Pg. 12)	Circle 14
UNITED RADIO CO. (Pg. 99)	Circle 146
WARREN ELECTRONICS COMPONENTS (Pg. 97)	Circle 143
WELLER ELECTRIC CO. (Pg. 69)	Circle 34
WINEGARD CO. (Pg. 24-25)	Circle 21
XCELITE, INC. (Pg. 53)	Circle 25

# NEW TEST EQUIPMENT

More information on new test equipment is available free from the manufacturers of items identified by a Reader's Service number. Turn to the Reader's Service Card facing page 72 and circle the numbers of the new products on which you would like information. Detach and mail the postage-paid card.

**WIDEBAND OSCILLOSCOPE, S-55A.** Features automatic sync, 500 kHz horizontal sweep, regulated calibration voltage, dc sensitivity, 70 millivolts per



inch . . . ac sensitivity, 25 millivolts per inch, variable illuminated screen graticule, camera mount bezel. Price, \$169.95.—Precision Apparatus, Div. of Dynascan Corp.

Circle 46 on reader's service card

**REGULATED DC POWER SUPPLY, KG-664** has B+ /filament/dc bias. Delivers 0-400V of regulated dc power at up to 200 mA continuously; 0-100 Vdc at 1 mA regulated for line variation; plus 6.3 Vac at 6A and 12.6 Vac at 3A for



filament supply voltage. 2 front panel meters continuously monitor voltage and current. Output voltage, less than 1.0% variation. Input voltage, less than 1.0% variation for  $\pm 10V$  variation at 120 Vac input. Capacity, 80W. Kit, \$94.50; assembled, \$140.—Allied Radio Corp.

Circle 47 on reader's service card

**7 TEST INSTRUMENTS IN 1 PACKAGE,** the *Stereo Commander, model 880.* Complete testing for audio, FM and multiplex. Solid-state. Portable. Has 4 signal sources and 3 measuring instruments. Signal sources include an audio generator that supplies sine or square wave signals; a multiplex simulator; an rf/sweep oscillator that may be used as

an FM source or as a sweep generator; and an oscillator that generates a crystal-controlled 10.7-MHz signal. Measuring instruments include an intermodulation distortion analyzer, an impedance bridge, and a high-impedance ac voltmeter with a sensitivity of 100 mV. Composite output,



5V peak-to-peak stereo, with 35 dB channel separation up to 10 kHz; 2.5V peak-to-peak monaural. Monaural audio output, 3V peak-to-peak, sine wave, and 10V peak-to-peak, square wave. 11½ x 9¼ x 6-in. \$329.95—Amphenol

Circle 48 on reader's service card

**SIGNAL STRENGTH METER FOR ANTENNAS,** the *AIM-718.* Solid-state. Portable. Battery-operated. Meter shows exact antenna requirements. Separate vhf and uhf tuners. Includes au-



dio output jack, crystal earphone and 2 built-in dB attenuators. Input impedance, direct 300 ohms, 75 ohms with transformer. Sensitivity, 20  $\mu V$  at 75 ohms, 40  $\mu V$  at 300 ohms. Accuracy, 3 dB on vhf and 6 dB on uhf. 9 x 6½ x 4-in. 4 lb, 6 oz.—Jerrold Electronics Corp.

Circle 49 on reader's service card

## sonotone's dynamic cardioid mike for taping

Are unwanted sounds spoiling your home tape recordings? Has



everyday household noise got you down? Sonotone has the unidirectional answer: Our CDM80 dual impedance microphone.

This Sonotone microphone features the discriminating cardioid pattern that professional performers prefer. Captures every word, note and nuance directed into it, while suppressing extraneous, distracting noises, boominess and feedback.

Complete with on-off switch, 15-foot cable and shield. Impedances of 200 ohms and 50K ohms. Price: \$43.50

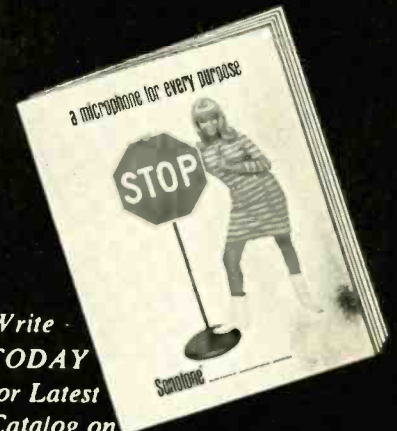

Write TODAY for Latest Catalog on Sonotone Microphones



ELECTRONIC APPLICATIONS DIVISION  
SONOTONE CORPORATION • Elmsford, N.Y. 10523  
Experts: Slinger Prods. Co., NYC. Cable: Etegrins, N.Y.

Circle 106 on reader's service card

# new Sams books

## Servicing Closed-Circuit Television



by Melvin Whitmer. Teaches the fundamentals of servicing closed-circuit television systems which are coming into widespread use. Clearly explains the differences between closed-circuit and home-type television. Describes how to set up various systems and how to maintain and repair complete installations. Covers types of systems and their applications in general terms, and describes specific makes and models. Includes schematics and other detailed data to provide a complete understanding of closed-circuit TV. 192 pages; 8½ x 11". Order 20574, only. \$4.25

specific makes and models. Includes schematics and other detailed data to provide a complete understanding of closed-circuit TV. 192 pages; 8½ x 11". Order 20574, only. \$4.25



## ABC's of Hi-Fi and Stereo (2nd Ed.)

by Hans Fantel. This newest revision gives you a full understanding of what high-fidelity and stereo are all about. Describes the basic principles of sound reproduction and what you should know to select, operate, and maintain equipment. Explains monaural and stereo sound and discusses the relative merits of consoles and component systems. Treats in detail the requirements of amplifiers, turntables, tone arms, cartridges, speakers, record changers, and tape recorders. Shows how to set up a sound system, how to get the most from it, and what to do in case trouble is encountered. 128 pages; 5½ x 8½". Order 20539, only. \$2.25

## ABC's of Vacuum Tubes

By Donald A. Smith. Gives you the basic understanding of the electron tube required for the study of electronics and modern circuitry. Explains the principles and operation of each basic tube type in language anyone can understand. Describes the factors affecting tube operation. Includes valuable formulas for the more serious student. 128 pages; 5½ x 8½". Order 20576, only. \$2.25

## Tape Recording for the Hobbyist (2nd Ed.)

by Art Zuckerman. While concerned with tape recording as a hobby, this revision of the book *Magnetic Recording for the Hobbyist*, also provides many ideas for important uses of the recorder in home and office. Describes special entertainment uses, ranging from party tricks and "detective-type" work to building a library of sound. Includes useful tips on microphones, special sound effects, candid recordings, correspondence recording, the versatile use of battery-powered portable recorders, tape editing, producing your own programs, synchronizing sound on tape, tape and recorder maintenance—plus home video tape recording. 160 pages; 5½ x 8½". Order 20583, only. \$3.25

## Controlled Guidance Systems



by Hal Hellman. This programmed text explains the fundamentals of guidance systems. Covers ballistic trajectory, hyperbolic guidance, motion, translation, proportional navigation, celestial navigation, and stellar inertial guidance. Explains the principles, operating characteristics, and construction of various systems, both active and passive. Describes the early history and development of missiles, from the V-2 bomb of World War

II to the far more sophisticated rockets and missiles used today. Topics and chapters end with test questions and answers to help reinforce learning; a final examination is included. 224 pages; 5½ x 8½". Order 20573, only. \$4.95

These and over 300 other SAMS Books are available from your local Electronics Parts Distributor . . .

HOWARD W. SAMS & CO., INC.  
4300 WEST 82nd ST. • INDIANAPOLIS, INDIANA 46205

Circle 107 on reader's service card

# NEW CB EQUIPMENT

More information on new CB equipment is available free from the manufacturers of items identified by a Reader's Service number. Turn to the Reader's Service Card facing page 72 and circle the numbers of the new products on which you would like information. Detach and mail the postage-paid card.

**5-CHANNEL CB TRANSCEIVER**, the *Courier TR-5*. Solid-state. 100% modulation. Illuminated channel selector. Auxiliary speaker jack. Single-knob tuning. Transmit and modulation indicators. *Safety-Circuit* to protect against mis-

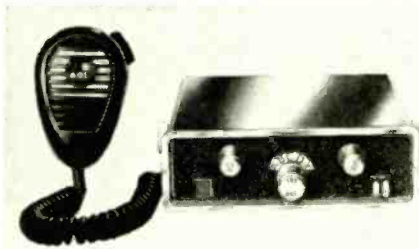

matched antenna, incorrect polarity, and overload. 10-yr. guarantee. Includes channel-9 transmit and receive crystals. 5¼ x 6¼ x 1½-in. \$99.—Courier Communications, Inc.

Circle 50 on reader's service card

**CB 2-WAY RADIO**, the *Director 23*. Solid-state. Hand wired. Amplified automatic gain control circuit. Cross modulation rejection, 80 dB down. Frequency synthesis uses only 2 frequencies. Transmitted frequency tolerance, ±.003 per-



cent. Has dual-conversion superhet receiver, high-gain audio power amplifier, negative peak clipping, high level saturation limiting, squelch and automatic noise-limiting circuitry. 8½ x 2½ x 8½-in. \$269.90—Pearce-Simpson, Inc.

Circle 51 on reader's service card

**SELECTIVE CALL UNIT**, the *Poly-Call TONE ALERT*, models *TC-1*, *TC-7*. Solid-state. The *TC-1* is a 1-tone unit which permits selective calling of all sta-



tions in the network; the *TC-7* is a 7-tone unit for individual calling of up to 7 stations. Both models have electronic filters. *TC-1*, \$59.95; *TC-7*, \$89.95—Polytronics Laboratories

Circle 52 on reader's service card

**HAND-HELD CB TRANSCEIVER**, model 80. 3W. 11 transistors. 2 diodes. Contains a new receiver module that utilizes low noise "front end" transistors and ceramic-disc filters. Sensitivity, better



than 0.5 mV at 10 dB S/N. Transmitter module features a switch that shifts from high to low power modes. Includes an 8-section telescoping antenna, pair of channel 11 crystals, leather case. \$119.95—Amphenol

Circle 53 on reader's service card

**11-CHANNEL TRANSCEIVER**, the *Skylark-366*. For use under a Class D CB license. Solid-state. Tantalum capacitors, filtered power leads, glass epoxy circuit board, Zener diode voltage regulator, enclosed plug-in relay. Can be used as a paging system. Includes an external loudspeaker jack. 22 transistors, 11



diodes. Power input, 5W. Nominal rf output, 3W. Receiver sensitivity, better than 0.4 mV for 6 dB S/N. Audio output, 3W. Receiver bandwidth, 7 kHz at 6 dB, 20 kHz at 40 dB. 2¼ x 6¼ x 9¼-in. 7 lb. 12V dc operation, \$179.95; ac operation, \$219.90—Kaar Electronics Corp.

Circle 54 on reader's service card

**SOLID-STATE CB SYSTEM**, The *Craig 4101* hand-held unit features an automatic noise-limiter, plug-in crystals, and superheterodyne circuitry with low-distortion transmitting amplifier. 7 tran-

sistors, 2 diodes, 1½-in. speaker. Includes output for earphone, built-in 28-in. 8-section telescopic antenna, 9V battery. 2¼ x 4 x 1½-in. \$44.95 per pair. The 4301 base station (shown) features a full-



power transmitter, double modulation, modulation limiter, high-gain speech compressor, silicon transistors. 5 channels. Operates on 12V systems. Includes a transmit/modulation lamp. \$99.95. Ac adapter bracket available, \$24.95—Craig Panorama, Inc.

Circle 55 on reader's service card

**CB MARINE ANTENNA.** The CHANNEL CAT is designed to eliminate the need for radials. Feed-point impedance, 52 ohms. Loading is through water-

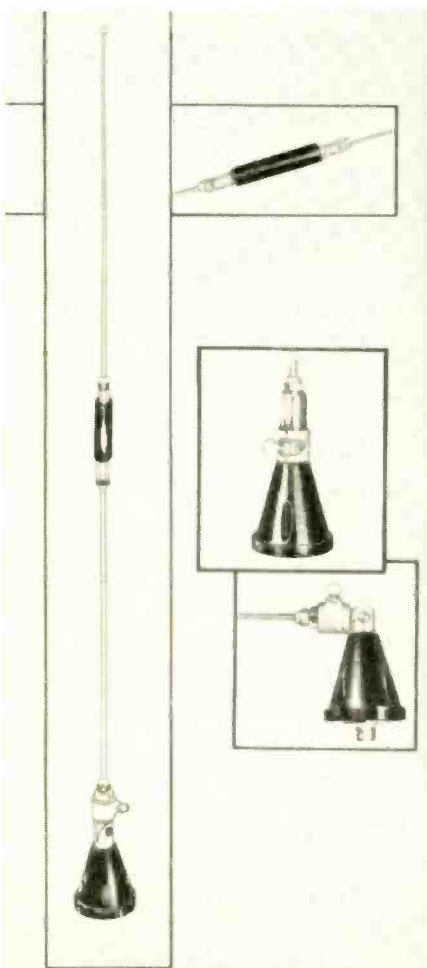

proof coil in antenna center and matching via a high-Q transformer. Weight, 2 lb. Height, 8 ft, ¾ in.—Mosley Electronics, Inc.

Circle 56 on reader's service card

# Solid State Circuit Boards

## Featuring Professional Performance at Low-Budget Prices

Model AA-100  
\$695

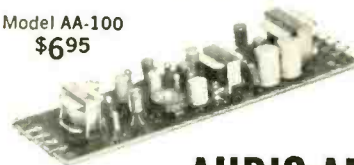

Model AA-300  
\$1495



### AUDIO AMPLIFIERS

Transistorized audio pre-amplifiers and amplifiers capable of delivering 200 MW of audio power, sufficient to drive a small speaker or a number of earphones. The AA-100, which includes a mounted volume control, is designed for general purpose audio applications and can also be used to modulate the TR-100 Transmitter (see below). The AA-300, a 200 MW amplifier, has excellent frequency response and low distortion characteristics which make it ideally suited for broadcast, recording, and TV applications. Either amplifier may be powered from a 9 volt source such as a battery or the PS-300 Power Supply. In applications where greater audio power is required, the AA-100 or the AA-300 may be used to drive the Model AA-400 Power Amplifier (see below).

	Model AA-100	Model AA-300
Frequency Response	±3 db, 100 to 12K cps	±1 db, 20 to 20K cps @ 200 MW ±2 db, 20 to 35K cps @ 100 MW
Harmonic Distortion	Less than 3%, 100 to 12K cps	Less than 1%, 20 to 20K cps @ 100 MW Less than 2%, 20 to 20K cps @ 200 MW
Input Impedance	150, 600, and 100K ohms (shielded transformer)	50 to 150 ohms, or 600 ohms, balanced (mu-metal shielded permalloy core transformer) 2K or 100K ohms unbalanced
Gain	70 db	80 db, 50 ohm input, 8 ohm load
Output Impedance	500 ohms and 8 ohms (grain oriented transformer) 200 MW	
Circuit	5 transistors, 1 thermistor	7 transistors, 1 thermistor
Power Supply	9 volts DC, 50 MA	9 volts DC, 100 MA
Size	5½" L x 1¾" W x 1" H	8" L x 2¼" W x 1½" H
Weight	3½ ounces	12 ounces

### 1-WATT AUDIO POWER AMPLIFIER



Model AA-400  
\$995

A transistorized audio power amplifier that can be driven to a full 1-watt output by a 1.5 volt signal. When the AA-400 is used with the Round Hill AA-100 or AA-300 Amplifier, a complete high gain, 1-watt audio system is obtained. Power can be furnished by any stable DC source delivering 14 volts at 150 MA, such as the PS-300.

Frequency Response.....	±1 db, 20 to 20K cps @ 1 watt	Output Impedance.....	4 to 16 ohms
Harmonic Distortion.....	Less than 1.5%, 20 to 20K cps @ 1 watt	Circuit.....	4 transistors
Input Impedance.....	500 ohms and 2,000 ohms	Power Supply.....	14 volts DC, 150 MA
		Size.....	3½" L x 2" W x 2" H
		Weight.....	3 ounces

### REGULATED POWER SUPPLY

The PS-300 is a zener-referenced, voltage regulated power supply which delivers a highly stable, extremely low ripple DC output of 9 volts with loads up to 200 MA and an unregulated output of 14 volts DC. The PS-300 is ideally suited for transistor circuit applications requiring a well-filtered regulated DC source, and may be used to furnish power to all Round Hill circuit boards.



Model PS-300  
\$1895

Input Voltage.....	105-120 volts AC, 60 cps, 5 watts	Output Voltage.....	9 volts DC fully regulated; 14 volts DC unregulated
Regulation.....	Line + load 5 MV	Size.....	4½" L x 2" W x 1½" H
Ripple.....	Under full load 10 MV, peak-to-peak	Weight.....	23 ounces (with transformer)
Maximum Load Current.....	200 MA		

### TRANSMITTER



Model TR-100  
\$1095

The TR-100 is a complete crystal controlled Transmitter for the Citizens' Band. It is factory pre-tuned and supplied with a channel 10 crystal. The Transmitter is capable of an RF output in excess of 100 MW and may be modulated with the Round Hill AA-100 Amplifier. Transmitter power supply requirements are 9 volts DC which can be obtained from the PS-300 Power Supply.

Circuit.....	Crystal controlled, 3 transistors	RF Output.....	100 MW, 50 ohm load
Frequency Range.....	Any CB channel (channel 10 crystal supplied)	Power Supply.....	9 volts DC, 50 MA
Modulation.....	CW or AM with external modulator such as Round Hill AA-100	Size.....	5½" L x 1¾" W x 2" H
		Weight.....	3½ ounces
		Additional CB Crystals.....	\$3.00 each



**ROUND HILL ASSOCIATES INC.** A SUBSIDIARY OF MILO ELECTRONICS  
434 Avenue of the Americas, New York, N.Y. 10011

PLEASE SEND ME THE FOLLOWING CIRCUIT BOARDS:

MODEL	QTY.	PRICE ea.	AMOUNT
AA-100 AUDIO AMPLIFIER		\$ 6.95	\$
AA-300 AUDIO AMPLIFIER		\$14.95	\$
AA-400 AUDIO POWER AMPLIFIER		\$ 9.95	\$
PS-300 POWER SUPPLY		\$18.95	\$
TR-100 TRANSMITTER		\$10.95	\$
CB CRYSTAL (channel: )		\$ 3.00	\$
		TOTAL:	\$

- Send postpaid—enclosed is full payment.  
 Send C.O.D.

NAME \_\_\_\_\_  
ADDRESS \_\_\_\_\_  
CITY \_\_\_\_\_  
STATE \_\_\_\_\_ ZIP \_\_\_\_\_

Yes, you can



YOU  
CAN  
BUILD

AN ARTISAN TRANSISTORIZED ORGAN WITH KITS AND SUB-ASSEMBLIES

**save \$2000 or more**

Easy enough to be fun. Difficult enough to be challenging.

Relax with one of the world's most rewarding hobbies . . . build a full-size, concert quality transistorized organ. The Artisan Kit Organ has the same rich pipe-like tones, the same features, as the famous Artisan Custom Organ. There's not one bit of difference in tonal beauty, console style, high quality.

10 styles for home, church, school



Write for brochure

Dept. RE  
1372 East Walnut Street  
Pasadena, Calif. 91106

Circle 108 on reader's service card

**COMPLETE TUNER OVERHAUL**

**9.95**

**ALL LABOR AND PARTS**  
(EXCEPT TUBES & TRANSISTORS)\*



**COLOR TUNERS**

GUARANTEED  
ALIGNMENT — NO  
ADDITIONAL  
CHARGE

Simply send us the defective tuner complete; include tubes, shield cover and any damaged parts with model number and complaint. Your tuner will be expertly overhauled and returned promptly, performance restored, aligned to original standards and warranted for 90 days.

UV combination tuner must be single chassis type; dismantle tandem UHF and VHF tuners and send in the defective unit only.

Exact Replacements are available for tuners unfit for overhaul. As low as \$12.95 exchange. (Replacements are new or rebuilt.)

And remember—for over a decade Castle has been the leader in this specialized field . . . your assurance of the best in TV tuner overhauling.

**CASTLE**  
TV TUNER SERVICE, INC.

5715 N. Western Ave., Chicago 45, Illinois  
41-96 Vernon Blvd., Long Island City 1, N. Y.

For service in Canada write to Chicago or use reader service card in this magazine.

\*Major parts are charged extra in Canada.

Circle 109 on reader's service card

## NEW PRODUCTS

**BATTERY OPERATED STUDIO MIXER**, the *Studio MixMASTER*, model 307TR. Solid-state. Stereo-mono audio frequency mixer/amplifier. Can be used with phonographs, microphones, electronic instruments, tape recorders. Distortion,



1% maximum. Frequency response, 20 Hz-20,000 Hz. Signal-to-noise ratio, 60 dB. Accepts up to 4 monaural or up to 2 stereo input signals from any combination. 3½ x 12 x 7½-in.—Switchcraft, Inc.

Circle 57 on reader's service card

**PORTABLE COLOR TV TEST UNIT**, the *Chek-a-Color*. Includes a 19-in., 90° rectangular bonded-shield color picture tube, deflection yoke, convergence assembly and blue lateral magnet assem-

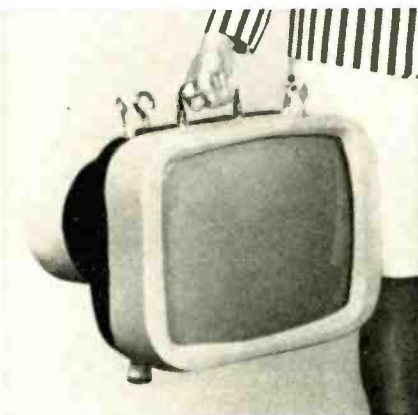

bly. Allows service technicians to check all 19- 21- 22- or 25-in. color TV receiver chassis without disturbing the neck components or picture tube. Under 50 lb.—Sylvania Electric Products, Inc.

Circle 58 on reader's service card

**REVERB UNIT**, model R-300. Solid-state. 12V. Features volume and reverb tone controls. Control between front and



rear speakers. Walnut wood and chrome face. Includes bracket for underdash mounting.—California Auto Radio, Inc.

Circle 59 on reader's service card

78

RADIO-ELECTRONICS

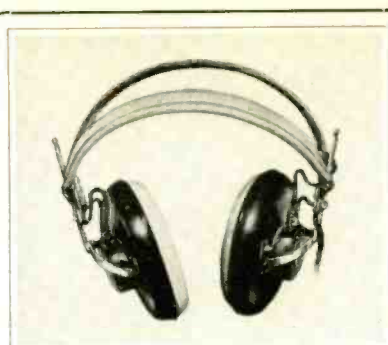

**PERMOFLUX . . .  
WILL GO TO  
YOUR HEAD . . .  
IF . . .**

you're seeking the ultimate in frequency response, superior engineering and durability. Write today for the dealer nearest you. A demonstration will prove to you why Permoflux headphones are used by the leading experts in all professions where sound is foremost.

All ear speakers are fully warranted for life.

STANDARD OF THE WORLD

**Permoflux** Corp.

P.O. Box 6364, Dept. RE 10  
GLENDALE, CALIFORNIA

Circle 110 on reader's service card

Enjoy the "music-only" programs now available on the FM broadcast band from coast to coast.

- NO COMMERCIALS •
- NO INTERRUPTIONS •



It's easy! Just plug Music Associated's Sub Carrier Detector into multiplex jack of your FM tuner or easily wire into discriminator. Tune through your FM dial and hear programs of continuous commercial-free music you are now missing. The Detector, self-powered and with electronic mute for quieting between selections, permits reception of popular background music programs no longer sent by wire but transmitted as hidden programs on the FM broadcast band from coast to coast. Use with any FM tuner. Size: 5½" x 9". Shipping weight approx. 7 lbs.

**KIT \$49.50**

(with pre-tuned coils, no alignment necessary)

**WIRED \$75.00** (Covers extra \$4.95 ea.)

Current list of FM Broadcast stations with SCA authorization \$1.00

**MUSIC ASSOCIATED**

65 Glenwood Road, Upper Montclair, N. J.  
Phone: (201)-744-3387 07043

Circle 111 on reader's service card

**82-CHANNEL AND VHF-TV/FM ANTENNA SERIES.** The 5 *VUfinder* models can be converted to *Coloraxial* reception by using an 82-channel matching transformer, model MUV-374. Includes model FS-1314 frequency separa-

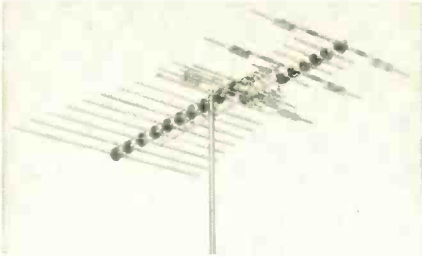

tors to split vhf from uhf for separate inputs into TV sets. *ColorPeak* models converted to *Coloraxial* reception by vhf matching transformer, model TO-374A.—Jerrold Electronics Corp.

Circle 60 on reader's service card

**MOBILE-PERSONAL CB TRANSCEIVER.** the *Pace-Mate*. Solid-state. 3 channels. 2W. Receiver has double conversion super-heterodyne design. Features 6-section tuned i.f. filter, shaped push-pull audio design, automatic noise limiting and tapered squelch control, and full stage automatic gain control. Includes detachable helical coil antenna, and *snap-back* power jack for operation on pen light batteries or rechargeable Nicad pack. 2½ x 1½ x 7¾-in. 1¼ lb. \$99.95—Pace Communications Corp.



Circle 61 on reader's service card

**ANTENNA SERIES.** *Super Color-tron*. Five 82-channel, 4 vhf and 3 uhf models. Solid-state preamp and terminal cartridges enable 300- and 75-ohm hook-ups. A spectrum filter cartridge shuts out all electromagnetic frequencies below 54

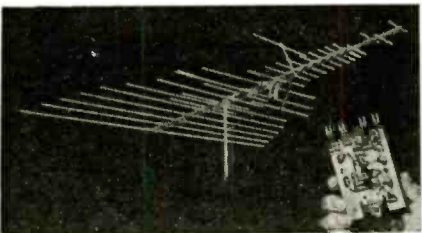

MHz. Uhf vertical resonant reflectors for enhanced vertical pickup of channels 14 to 83. Other elements peak channels 52 to 83. Anodized boom is ellipsoidal shaped for greater strength.—Winegard

Circle 62 on reader's service card

#### CORRECTION

**MODEL ADV-606 SOLID-STATE FM STEREO RECEIVER** (July, 1967) is manufactured by Audio Dynamics Corporation, not by Singer Products Co. as reported. R-E



**EFFICIENT!  
SAFE!  
FAST!**

## AUTOMATIC STAPLE GUNS



For Fastening Any Inside or Outside

Wire Up to 1/2" in Diameter

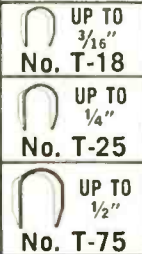

- UP TO 3/16" No. T-18
  - UP TO 1/4" No. T-25
  - UP TO 1/2" No. T-75
- Telephone wire
  - Intercom wire
  - Bell wire
  - Thermostat wire
  - Radiant heating wire
  - Hi-Fi, Radio & TV wires
- Tapered striking edge gets into close corners!

Available in:  
Brown, Ivory, Beige,  
Monel, Bronze, Natural

ARROW FASTENER COMPANY, INC.

SADDLE BROOK, N. J. 07663

Circle 112 on reader's service card

Fill in coupon for a FREE One Year Subscription to OLSON ELECTRONICS' Fantastic Value Packed Catalog—Unheard of LOW, LOW PRICES on Brand Name Speakers, Changers, Tubes, Tools, Stereo Amps, Tuners, CB, Hi-Fi's, and thousands of other Electronic Values. Credit plan available.

NAME \_\_\_\_\_  
ADDRESS \_\_\_\_\_  
CITY \_\_\_\_\_ STATE \_\_\_\_\_  
GIVE ZIP CODE \_\_\_\_\_

If you have a friend interested in electronics send his name and address for a FREE subscription also.

**OLSON ELECTRONICS, INC.**  
730 S. Forge Street Akron, Ohio 44308

Circle 113 on reader's service card

# Popular Science Top-Rates Scott's Stereo Tuner Kit

(THERE'S A SOUND REASON.)



Popular Science magazine's reviewer said, "I rate the LT-112-B as one of the finest FM tuners available — in or out of kit form." All of this fabulous tuner's critical circuitry comes pre-wired, pre-tested, and pre-aligned . . . and the full-size, full-color instruction manual makes the rest simple. In just eight hours, you'll have it completed. Again, in the reviewer's words: "Stereo performance is superb, and the set's sensitivity will cope with the deepest fringe area reception conditions . . . drift is non-existent." See your Scott dealer and review the new LT-112B-1 for yourself. Only \$199.95.



©Copyright 1967, H.H. Scott, Inc.

H.H. Scott, Inc., Dept. 570-10, Maynard, Mass. 01754. Export: Scott International, Maynard, Mass. 01754

Circle 100 on reader's service card

Get Top **PERFORMANCE** from  
your Car! **Buy The Best!**



**DELTA'S Remarkable, Proven**

# MARK TEN CAPACITIVE DISCHARGE IGNITION SYSTEM

ONLY  
**\$44.95**  
ppd.



Available in Easy-to-Build

## DELTAKIT®

ASSEMBLE IT  
YOURSELF!

ONLY  
**\$29.95**  
ppd.

You've read about the Mark Ten in Radio Electronics, Electronics World, Mechanix Illustrated, Electronics, Popular Mechanics and other leading publications! Now discover what dramatic improvement in performance with capacitive discharge ignition is yours for your car, truck, jeep, boat—any vehicle! Delta's remarkable electronic achievement—on the market since 1963 and so unique that a patent has been granted—saves on gas, promotes better acceleration, gives your car that zip you've always wanted. Even Detroit has finally come around. Delta's Mark Ten, the original, the proven winner from Sebring to Suburbia, has set new records of ignition benefits attested to by thousands of satisfied purchasers. No re-wiring necessary. Works on literally any type of gasoline engine. Satisfaction guaranteed.

Order from coupon below, specifying car make, voltage and polarity. Like to build your own? Order a Deltakit® and save!

### COMPARE THESE PROVEN BENEFITS!...

- ▲ DRAMATIC INCREASE IN ACCELERATION
- ▲ LONGER POINT AND PLUG LIFE
- ▲ IMPROVED GASOLINE MILEAGE
- ▲ MORE COMPLETE COMBUSTION
- ▲ SMOOTHER PERFORMANCE

Order Your Mark Ten Today! Shipped Postpaid at Once.



## DELTA PRODUCTS, INC.

P.O. BOX 1147 RE — GRAND JUNCTION, COLORADO 81501

Enclosed is \$ \_\_\_\_\_ Ship prepaid.  Ship C.O.D.   
 Mark Tens (Assembled) @ \$44.95  Mark Tens (Deltakit®) @ \$29.95  
(12 volt positive or negative ground only)

Specify  6 Volt: Negative Ground only.  
 12 Volt: Specify  Positive Ground  Negative Ground

Car Year \_\_\_\_\_ Make \_\_\_\_\_

Name \_\_\_\_\_

Address \_\_\_\_\_

City/State \_\_\_\_\_ Zip \_\_\_\_\_

Circle 115 on reader's service card

## NEW LITERATURE

All booklets, catalogs, charts, data sheets and other literature listed here are free for the asking with a Reader's Service number. Turn to the Reader's Service Card facing page 72 and circle the numbers of the items you want. Then detach and mail the card. No postage required!

**TRANSFORMERS, INDUCTORS AND TOROIDS.** 32-page catalog lists transformers, inductors and toroids, and features a section on commercial/industrial transformers and reactors for use in instrumentation and automation applications. Also includes charts, graphs, applications, schematics and notes.—Microtran Co., Inc.

Circle 63 on reader's service card

**CAPACITORS AND SEMICONDUCTORS.** 6-page catalog for hobbyists, engineers, repairmen and experimenters. Covers ceramic disc capacitors, ceramic tubular capacitors, precision trimmer capacitors, film capacitors and semiconductors. Drawings and charts with data and ordering information are included.—Erie Technological Products

Circle 64 on reader's service card

**FREQUENCY CONTROL CRYSTALS.** 12-page catalog includes prices and engineering data on crystals and holders for low-, medium- and high-frequency industrial standards. General purpose and special applications as well as crystals for Citizens band, marine and amateur use are included.—Texas Crystals

Circle 65 on reader's service card

**MOLDED-ON PLUGS AND CONNECTORS.** Catalog describes stereo headset extension coil cords, guitar coil cords and plugs, connectors and cables for hi-fi and other audio applications. Barker Products Co.

Circle 66 on reader's service card

**SOLID STATE SWITCHES.** 4-page brochure No. 30-10 describes physical dimensions, electrical characteristics and capabilities of complete line of solid-state switches.—American Electronic Laboratories, Inc.

Circle 67 on reader's service card

**CLOSED-CIRCUIT TELEVISION.** Booklet describes various types of system connections, camera block diagrams, monitor diagrams, camera lenses. Shows where CCTV sales market is and explains how to install.—GBC America Corp.

Circle 68 on reader's service card

**TECHNICAL BOOKS.** Sams Technical-Scientific Book Catalog lists more than 300 titles, for all levels from beginner to engineer. Includes topics such as electronics in oceanography and space science.—Howard W. Sams & Co., Inc.

Circle 69 on reader's service card

**NUTDRIVERS.** Illustrated bulletin No. N567 describes two sets of color-coded nutdrivers in "keep and carry" cases. Set No. HS6-18 consists of 10 hollow-shaft nutdrivers with hex openings ranging in size from 3/16" to 9/16". Set No. 77 has 7 nutdrivers with hex openings from 3/16" to 3/8". All have precision fit, case-hardened sockets.—Xcelite Inc.

Circle 70 on reader's service card



**SUB-MINIATURE INDICATOR LIGHTS.** Twelve-page illustrated catalog No. L-178B describes both incandescent and neon types. Data, specs, drawings and ordering information is provided for dimming and non-dimming types. Indicators have plastic lens caps in a wide range of colors.—Dialight Corp.

Circle 71 on reader's service card

**ELECTROLYTIC CAPACITORS.** 32-page guide includes all electrolytic capacitors used in color chassis from 32 TV set manufacturers. Indicates recommended Color-Lytic replacement by cross-reference to the OEM number, or by direct reference to rating capacitance/voltage for single, dual, triple and quadruple section units. Contains listing of printed circuit types for replacement.—Cornell-Dubilier Electronics

Circle 72 on reader's service card

**WIRE, SWITCHES AND HARDWARE.** 64-page catalog features dimensional diagrams, illustrations, and other data on wire, cable, tubing, electronic hardware, switches, and other radio-TV accessories and components.—Birnback Co., Inc.

Circle 73 on reader's service card

**MAGNETIC TAPE SYSTEMS.** 8-page brochure lists professional-quality tape recorders and systems for home, studio and industry.—Teac Corp.

Circle 74 on reader's service card

**TAPING TIPS FOR ELECTRONIC SERVICING.** Concerns insulating tape. For both hobbyists and professionals, this 32-page illustrated booklet describes 21 topics including power input connections, wiring harnessing, circuit isolation protection and antenna and lead-in protection. Also tells how to avoid cold weather problems and how to achieve high temperature stability even in areas of atmospheric or chemical contamination.—3M Co.

Circle 75 on reader's service card

**MINIATURE SWITCHES, RELAYS AND HARDWARE.** 12-page catalog features Design Ideas for Engineers. Includes miniature electronic switches, remote-control relays, readout indicators and pilot lights, ceramic terminal strips, and machined aluminum knobs. Contains complete listings and prices, drawings and engineering specs.—Aleo Electronic Products, Inc.

Circle 76 on reader's service card

**TEFLON-COATED TWEEZERS.** 80-page catalog describes all standard shapes available in nickel-plated steel and stainless antimagnetic steel. Teflon coating now available. For use in all semiconductor handling.—Techni-Tool, Inc.

Circle 77 on reader's service card

**ELECTROLYTIC CAPACITORS.** Catalog No. 4-81 describes computer-grade aluminum electrolytic capacitors with over 900 size ratings. Units have pressure-sensitive safety-vent construction, temperature range from -40° to +85° C, and higher capacitance. No. 4-74B covers MTA and MTV molded-case electrolytic capacitors in 12 different case sizes, voltage range of 3 to 50 Vdc, capacitance to 1,000 µF. Available with either axial or vertical leads. No. 4-82 covers TIM (radial leads) and TAC (axial leads) molded, solid-electrolyte tantalum capacitors featuring epoxy molded case, printed-circuit board compatibility.—Mallory Capacitor Co.

Circle 78 on reader's service card

**ELECTRONICS TRAINING.** 3 catalogs. FCC License by Correspondence. Gives different kinds of operator licenses with descriptions and costs. Associate Degree Curriculum. Gives all information needed to apply. Communications Electronics Resident Training. Latest information on enrollment details, schedules, starting dates, tuition and necessary forms.—Grantham School of Electronics R-E

Circle 79 on reader's service card

You can't buy a better recording tape at any price



IRISH MAGNETIC RECORDING TAPE  
458 Broadway, New York, N. Y. 10013

**NAVY MARINE BAND WALKIE TALKIE**

**TRANS. & RECEIVER**—Crystal controlled, can be operated on any one channel in freq. range 2.3 to 4.5 MC. Voice (A3) communication only; output of Trans. is 0.2 watts & satisfactory communication between units should be maintained up to approx. one (1) mile. With tubes: 1/185, 1/115, 2/174, 3/384. Voltages required: 67.5 VDC 3 MA; 135 VDC 4 MA; 1.5 VDC 225 MA for REC. —07.5 VDC 1.5 MA; 135 VDC 19 MA; 1.5 VDC 225 MA; & —6 VDC 30 MA for TRANS. Waterproof plastic case w/space for batt. or power supply. Telescoping antenna 8 ft. has special loading coil. Complete w/tubes, antenna, 2 crystals FT-213 (no choice of freq.) headphones, carbon mic., canvas cover, & manual. Size: \$9.95

**"DAV" MODEL**—Same as above, but with direction finding loop circuit for homing; & lip. mic. Ply-wood case w/ carrying straps. Wt.: 11 lbs. \$12.95

Dry Charge Battery N-T-6 f/above Pow. Sup. \$3.95  
Vibrator Power Supply f/MA3 & DAV—New \$6.95  
Prices F.O.B. Lima, O. — 25% Deposit on COD's — BIG FREE CATALOG—Send for your copy now, Dept. RE

**FAIR RADIO SALES**  
1016 E. EUREKA • Box 1105 • LIMA, OHIO • 45802

New Perma-Power Solutions

to these common color TV

problems problems problems problems

washed-out unclear color pictures from loss of the black-and-white



**color-brite**  
ISOLATION BRITENER (NO BOOST)  
CORRECTS FOR CATHODE-TO-FILAMENT SHORTS—RESTORES BLACK & WHITE—REVIVES COLOR QUALITY

MODEL C-502 for round tubes \$7.25 net

MODEL C-512 for rectangular tubes \$7.25 net

picture distortion shrinking, flutter, flop-over, dullness from low line voltage

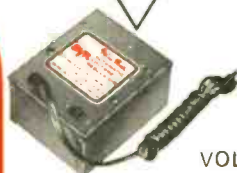

**avR**

400 WATT AUTOMATIC VOLTAGE REGULATOR

Automatically boosts voltage 10 volts when line drops below 110 V—automatically cuts out when line is normal—Maximizes color TV set performance

MODEL D-210 400 watt AVR \$14.95 net

These units are now available from your Perma-Power distributor. Write for Catalog LCB-68 on the full line of Perma-Power products for color and black and white TV service.

**Perma-Power COMPANY**

5740 North Tripp Avenue  
Chicago, Illinois 60646  
Phone (312) 539-7471

Circle 116 on reader's service card

# NEW! LAFAYETTE HB-525B Solid State 2-Way Radio

WITH "S/PRF" Meter



99-3144WX\*

- Size: 2 3/8" by 6 1/4"

**149<sup>95</sup>**

## 23 CB Crystal Controlled Channels All Crystals Supplied

- 19 Transistors, 9 Diodes, Thermistor
- Dual Conversion Receiver for Extra Selectivity and Sensitivity
- Full 5-Watt Input
- Range Boost™ Circuitry for Added Power
- 3-Position Delta Tune—Provides Accurate Fine Tuning
- Mechanical 455KC Filter for Superior Selectivity
- Push-to-Talk Dynamic Microphone
- Variable Squelch plus Series Gate Automatic Noise Limiting
- Public Address System (with external speaker)
- 12-Volt DC Operation (pos. or neg. ground) 6-Volt DC (with optional DC Power Supply)
- Accepts Priva-Com® Plug-in Tone Caller

\*Imported



**FREE**

JUST OFF PRESS!

1968

**CATALOG 680**

Over 500  
Pages

Featuring Everything in Electronics for

• HOME • INDUSTRY • LABORATORY

from the "World's Hi-Fi & Electronics Center"

LAFAYETTE Radio ELECTRONICS  
Dept. JJ-7, P.O. Box 10  
Syosset, L. I., N. Y. 11791

Send me the FREE 1968 Lafayette Catalog 680

JJ-7

Name .....

Address .....

City ..... State ..... Zip .....

Circle 117 on reader's service card

# TECHNOTES

## ADMIRAL 14UY3B

**Complaint:** Horizontal sync instability increases with temperature. Horizontal pulling began about an hour after the set was turned on. In about two hours, horizontal sync was difficult to hold and there was a tendency toward vertical rolling.

**Remedy:** Checks in the sync amplifier and inverter stages showed that coupling capacitor C430 was slightly leaky. Re-

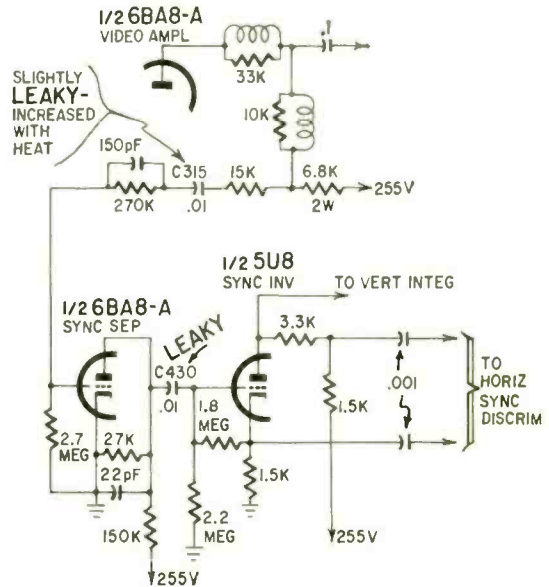

placing it reduced the symptoms but did not eliminate them. Since the problem was obviously thermal, we tried holding a hot soldering iron close to the capacitors in the circuit. The symptoms got worse when the iron was close to C315. The trouble cleared up when this unit was replaced.—Homer Davidson

## RCA YGG '45 STEREO RECORDER

Hum in the right channel is peculiar to only some of these units and can be corrected by changing the value of R91 to 470 ohms.—RCA Radio and Victrola Service Tips

## RCA VGT 66 PHONO

**Complaint:** A loud pop, heard in the speakers when the pickup touches the record, cannot be eliminated by adjusting the muting switch. This occurs when the charge and discharge cycles of capacitors C401 and C402 (see diagram) do not follow the muting switch action.

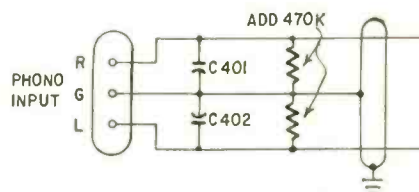

**Remedy:** This can be corrected by connecting a 470,000 ohm, 1/2-watt resistor across each phono input channel as shown.—RCA Radio and Victrola Service Tips

R-E

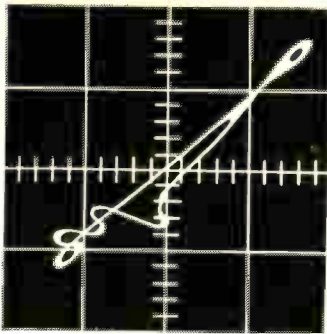

Fig. 9. Right-channel mistracking. Antiskate force is needed.

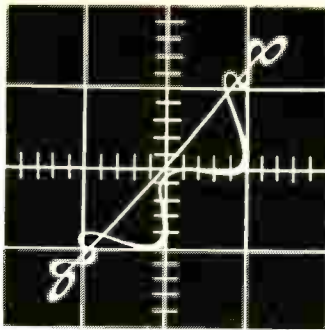

Fig. 10. Tracking limits . . . no further correction is possible.

## Cartridge Tracking Tests

*continued from page 34*

trace as shown in Fig. 9 and can be corrected by adding antiskate force. If the pickup arm has an antiskating mechanism, adjust it in accordance with the manufacturer's instructions. Elliptical styli require about 1.5 times the antiskating force of conical styli. When this tracking error is corrected and a trace as shown in Fig. 8 is obtained, go on to the next most difficult tracking band. Continue this procedure until no further improvement can be obtained, or until equal mistracking occurs on both channels, as shown in Fig. 10.

Antiskating force is properly adjusted for the tracking force in use when both channels mistrack equally. The velocity band just below the one being used, where a normal trace is obtained, is the maximum tracking capability of the cartridge at the measured tracking force. Should you need a greater tracking capability, you can increase stylus pressure, but do not exceed the cartridge manufacturer's specification.

Left-channel mistracking, due to excessive antiskate force or excessive tone-arm friction, distorts the waveform as shown in Fig. 11. Correction is obvious; either reduce the antiskate force or repair the tone arm. Reduction in stylus pressure could be beneficial in some instances, but don't go below specifications.

### OTHER TROUBLES

In the event you get a trace going up toward the left as shown in Fig. 12 (instead of a trace going up toward the right as in Fig. 8), check the wiring of the cartridge leads and the leads of the test setup. **R-E**

Fig. 11. Left-channel mistracking due to excessive antiskate.

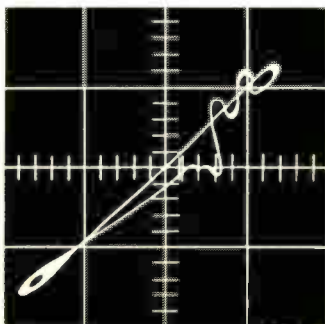
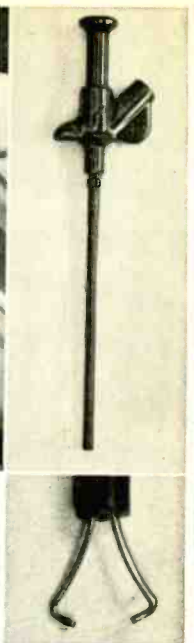
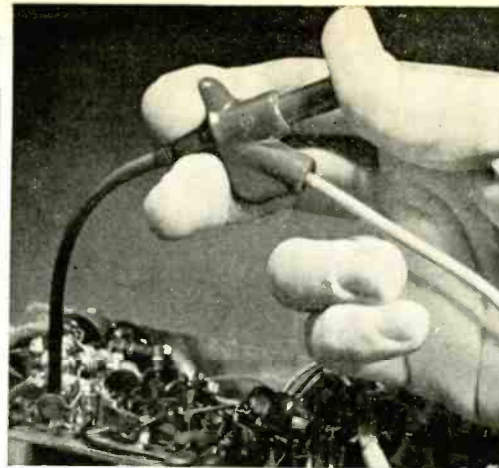
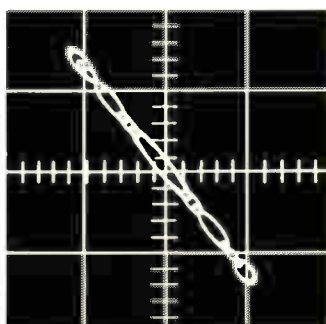



Fig. 12. Tracking is normal, but something is out of phase.



## Clever Kleps 30

Push the plunger. A spring-steel forked tongue spreads out. Like this  Hang it onto a wire or terminal, let go the plunger, and Kleps 30 holds tight. Bend it, pull it, let it carry dc, sine waves, pulses to 5,000 volts peak. Not a chance of a short. The other end takes a banana plug or a bare wire test lead. Slip on a bit of shield braid to make a shielded probe. What more could you want in a test probe?



Available through your local distributor, or write to:

**RYE INDUSTRIES INC.**

126 Spencer Place, Mamaroneck, N.Y. 10543  
Circle 118 on reader's service card

**\$147**

**GET THIS FREE**



## GAS MILEAGE COMPUTER

from your local parts distributor with purchase of any 3 TECHPRESS hobbyist-experimenter books (\$1.25 up), or one complete set of

**ACTION ELECTRONICS . . . For The Handyman**

There are books on easy-to-build semiconductor circuits, basics books on Oscillators, Microphones, Modulation, Audio and RF Amplifiers, Antennas, Power Supplies, Transistors, Diodes, etc., etc.

See local parts distributor or book store for free catalog; or write TECHPRESS, INC., Brownsburg, Ind. 46112

Gas Mileage Computer supply limited. Act Now!

**TECHPRESS, INC.**

Circle 119 on reader's service card

**WORLD'S FINEST**  
**5-CORE SOLDER**

**ERSIN MULTICORE**  
**NEW EASY DISPENSER PAK ONLY 69¢**

BUY IT AT RADIO-TV PARTS STORES  
MULTICORE SALES CORP. WESTBURY, N.Y. 11590  
Circle 120 on reader's service card

# NEW SEMICONDUCTORS

## IC'S FOR ELECTRONIC ORGANS

The MC1124P and MC1120P are two new Motorola IC's designed specifically for electronic organs. The MC1124P is an MOS frequency divider consisting of four toggle flip-flops. Two are cascaded internally and two are separate. This makes possible a divider chain using flip-flops from a single package or from separate packages. Toggle frequency range is dc to 500 kHz. A

typical electronic-organ divider chain would consist of 12 IC's.

The MC1120P is an MOS dual-keyer gate with sustain inputs. It is designed for the keying section and provides for channeling several notes at each key. Intermodulation is low and isolation is better than 70 dB.

Both IC's offer noise immunity of 1.0 volt and a minimum fanout of 5 over a range of 0° to 75°C. The photo contrasts integrated-circuit and discrete-component construction of equivalent sections of a divider chain.

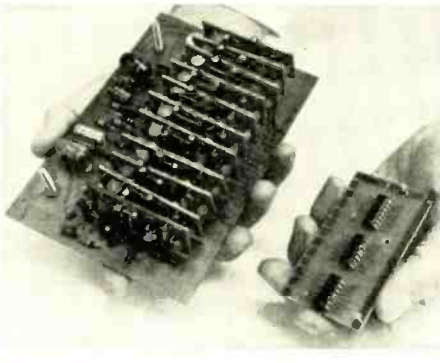

## SOLID-STATE PHOTOCCELL DRIVER

The SSL-1 is a new solid-state lamp or light-emitting diode with a visible light output of 0.8 foot-lamberts per mA. More rugged than glow or filament lamps, this new General Electric diode is mounted on a TO-18 header with a lens window and a gold case. It can be used as an indicator and a driver for photocell circuits. Maximum ratings

**FREE \$1 BUY WITH EVERY 10 YOU ORDER** Only applies to "\$1" Buys **FREE GIFT WITH EVERY ORDER**

## \$1000 REWARD

**TO ANYONE**—Who can show us an Established Competitor who could sell & deliver all the items on this list at the prices & in the quantities that we do! **HOW DO WE DO IT?**

Our **TREMENDOUS BUYING POWER & PURCHASING EXPERIENCE** make it possible. We invest Thousands of Dollars (in just a single item) to create a good **DOLLAR BUY**, resulting in the **AMAZING & EXCITING OFFERS** that follow:

- |   |   |  |   |
|---|---|--|---|
| <input type="checkbox"/> \$25 TAPE RECORDER (6-Trans.) good, needs adjusting, complete less Mike—money-back guarantee . . . \$6 | <input type="checkbox"/> 4 — TV ALIGNMENT TOOLS most useful assortment . . . \$1  | <input type="checkbox"/> <b>RCA 110° FLYBACK TRANSFORMER</b>   | <input type="checkbox"/> UNIVERSAL 4" PM SPEAKER Alnico 3 magnet, quality tone . . . \$49       |
| <input type="checkbox"/> MIKE special for this Recorder \$1.19  | <input type="checkbox"/> 7 — ASST. TV ELECTROLYTIC CONDENSERS popular selection . . . \$1                                     |  We scooped the Market Latest type — standard for all 110° TV's<br>RCA's design of large Coil produces 18KV—assuring adequate width Incl Schematic Diagram application for any TV<br>List price \$13.00<br>Your price . . . \$3<br>10% off in lots of 3 | <input type="checkbox"/> 100 — ASST. RADIO KNOBS all selected popular types . . . \$1           |
| <input type="checkbox"/> 1 — LB SPOOL ROSIN-CORE SOLDER 40/60 top quality . . . \$1   | <input type="checkbox"/> \$15.00 TELEVISION PARTS "JACKPOT" best buy ever . . . \$1   | <input type="checkbox"/> 110° TV DEFLECTION YOKE for all type TV's incl schematic same as Thorlerson Y502 list \$20 \$3  | <input type="checkbox"/> 40 — ASSORTED TV KNOBS all standard types, \$20 value . . . \$1        |
| <input type="checkbox"/> 2—G.E. PIECES OF EQUIPMENT stacked with over 200 useful parts . . . \$1                                | <input type="checkbox"/> BONANZA "JACKPOT" not gold, not oil, but a wealth of Electronic Items—Money-Back-guarantee . . . \$5 | <input type="checkbox"/> "COMBINATION SPECIAL" RCA 110° FLYBACK plus 110° DEFLECTION YOKE . . . \$5  | <input type="checkbox"/> 10—ASSORTED DIODE CRYSTALS 1N34, 1N48, 1N60, 1N64, etc. . . \$1        |
| <input type="checkbox"/> 25 — TUNGSOIL FLASHLIGHT BULBS #416, bayonet, 3.3 v, 2w . . . \$1                                      | <input type="checkbox"/> 10 SETS — DELUXE PLUGS & JACKS asst. for many purposes . . . \$1                                     | <input type="checkbox"/> 90° FLYBACK TRANSFORMER for all type TV's incl schematic \$2  | <input type="checkbox"/> 10—STANDARD TRANSISTORS NPN & PNP 2N404, 2N414, etc. . . \$1           |
| <input type="checkbox"/> 50 — ASSORTED MYLAR CONDENSERS popular selected types . . . \$1  | <input type="checkbox"/> 10 — SETS PHONO PLUGS & PIN JACKS RCA type . . . \$1   | <input type="checkbox"/> 90° TV DEFLECTION YOKE for all type TV's incl schematic . . . \$2   | <input type="checkbox"/> 5 — TOP HAT SILICON RECTIFIERS 500ma-400v — big value . . . \$1        |
| <input type="checkbox"/> 100 — MIXED DEAL "JACKPOT" Condensers, Resistors, Surpluses . . . \$1                                  | <input type="checkbox"/> 10 — SURE-GRIP ALLIGATOR CLIPS 2" plated . . . \$1   | <input type="checkbox"/> 70° FLYBACK TRANSFORMER for all type TV's incl schematic \$1  | <input type="checkbox"/> 10—TRANSISTOR RADIO EARPIECES wired complete with plug \$1             |
| <input type="checkbox"/> 10—ASSORTED SLIDE SWITCHES SPST, SPDT, DPDT, etc. . . . \$1  | <input type="checkbox"/> 50 — RADIO & TV SOCKETS all type 7 pin, 8 pin, 9 pin, etc. . . \$1                                   | <input type="checkbox"/> 70° TV DEFLECTION YOKE for all type TV's incl schematic \$1   | <input type="checkbox"/> 100 — ASST. TUBULAR CONDENSERS .001 to .47 to 600 v . . . \$1          |
| <input type="checkbox"/> 20 — EXPERIMENTER'S COIL "JACKPOT" assorted for 101 uses . . . \$1                                     | <input type="checkbox"/> 50 — ASSORTED #3AG FUSES popular ampere ratings . . . \$1  | <input type="checkbox"/> 20—ASSORTED TV COILS I.F. video, sound, ratio, etc. . . . \$1   | <input type="checkbox"/> 5—ASSORTED TRANSFORMERS Radio, TV and Industrial . . . \$1             |
| <input type="checkbox"/> 20—ASST. PILOT LIGHTS #44, 46, 47, 51, etc. . . . \$1  | <input type="checkbox"/> 100 — STRIPS ASSORTED SPAGHETTI handy sizes . . . \$1  |  | <input type="checkbox"/> TV TUNERS assorted types less Tubes, sold at random . . . \$1          |
| <input type="checkbox"/> 50 — ASST. DISC CERAMIC CONDENSERS popular numbers . . . \$1   | <input type="checkbox"/> 100—ASSORTED RUBBER GROMMETS best sizes . . . \$1  |  | <input type="checkbox"/> TV TUNERS including Tubes, sold at random . . . \$3                    |
| <input type="checkbox"/> 10 — ASST. RADIO ELECTROLYTIC CONDENSERS . . . \$1   | <input type="checkbox"/> 50—ASSORTED PRINTED CIRCUIT SOCKETS best types . . . \$1   |  | <input type="checkbox"/> TV TUNERS VHF/UHF part types including Tubes, sold at random . . . \$6 |
| <input type="checkbox"/> 20 — STANDARD TUBULAR CONDENSERS .047-600v . . . \$1   | <input type="checkbox"/> 10—ASSORTED VOLUME CONTROLS less switch . . . \$1  |  | <input type="checkbox"/> 10 — G.E. SAPPHIRE NEEDLES 4G, VR-11, etc. (\$25.00 value) . . \$1     |
| <input type="checkbox"/> 3—½ MEG VOLUME CONTROLS with switch, 3" shaft . . . \$1  | <input type="checkbox"/> 7—ASSORTED VOLUME CONTROLS with switch . . . \$1   |  |   |

**IMMEDIATE DELIVERY . . .** Scientific light packing for safe delivery at minimum cost.  
**HANDY WAY TO ORDER:** Pencil mark or write amounts wanted in each box, place letter F in box for Free \$1 BUY. Enclose with check or money order, add extra for shipping. Tearsheets will be returned as packing slips in your order, plus lists of new offers.

Name . . . . .  
Address . . . . .  
Cost of Goods . . . . .  
Shipping estimated . . . . .  
TOTAL

Please specify refund on shipping overpayment desired:  CHECK  POSTAGE STAMPS  MERCHANDISE (our choice) with advantage to customer

**BROOKS RADIO & TV CORP., 487 Columbus Ave., New York, N. Y. 10024** TELEPHONE 212-874 5600

# AND MICROCIRCUITS

are: reverse voltage, 5; forward dc, 75 mA; storage temperature -65°C to 125°C. Typical dc characteristics at 25°C and 50 mA are:

Forward voltage	3.5 volts
Brightness (end on)	40 foot-lamberts
Rise time to 2/3 max brightness	< 100 μsec
Fall time to 1/3 max brightness	< 100 μsec
Peak spectral emission	5,900 Å
0.707 peak band-width	5500-6300 Å

### 2N5108 AND 2N5109

These RCA transistors are epitaxial npn silicon types featuring overlay emitter construction. The 2N5108 is a high-gain unit for class-B or -C opera-

tion in uhf applications. It can operate as a fundamental oscillator up to 1.68 GHz. A minimum of 1-watt output is available at 1 GHz (5 dB gain). Absolute maximum voltages are:  $V_{CBO}$  55,  $V_{CEB}$  ( $R_{BE} = 10$  ohms) 55,  $V_{CEO}$  30 and  $V_{EBO}$  3.

The 2N5109 is especially designed to provide large dynamic range, low distortion and low noise for such uses as MATV and CATV amplifiers. Absolute maximum voltages are:  $V_{EBO}$  40,  $V_{CEB}$  ( $R_{BE} = 10$  ohms) 40 and  $V_{EBO}$  3.

Both transistors are in TO-39 cases and dissipate 3.5 W at case temperatures up to 25°C. R-E

## LIFE INSURANCE

ISSUED BY MAIL • KEEP IT FOR LIFE  
**MAIL THIS AD** NO OBLIGATION  
APPLICATION MAILED TO YOU

\$5000 ENTRY AGES 21 to 70 • \$2000 ENTRY AGES 21 to 80  
Whole Life Policy pays world-wide for death from any cause, any time, except during first policy year for either suicide or death from undisclosed pre-existing health conditions. Mail your name, address, zip code, year of birth and ad to Great Lakes Insurance Co., Elgin, Ill. 60120 Dept. KD125J6



**ASSEMBLED \$54.95**      **KIT FORM \$44.95**  
**\$5 DOWN - \$5 MONTH**

Walnut finished cabinet included  
Shipped REA Collect

Easy to build, easy to install. All transistor AUDIO-COLOR adds a visual dimension to musical enjoyment. A brilliantly moving panorama of color casts dancing images on a soft frosted screen, reflecting rising and falling volume with each beat of the music. Here's a truly unique and exciting new musical experience. Make check or money order to CONAR.

SEND FOR FREE CONAR CATALOG

**CONAR** Division of National Radio Institute  
Dept. KC7C, 3939 Wisc. Ave., Washington, D.C. 20016

CANADIANS: Ordering is easy . . . we do the paperwork . . . try a small order

**SARKES TARZIAN TV TUNER 41mc**  
Latest Compact Model—good for all 41 mc TV's.  
BRAND NEW—MONEY BACK GUARANTEE

Best TUNER "SARKES TARZIAN" ever made—last word for stability, definition & smoothness of operation. An opportunity — to improve and bring your TV Receiver up-to-date.

COMPLETE with Tubes & Schematic . . . \$7.95

**HIGHWAVE AM-FM PORTABLE RADIO**  
Elegance in Ebony & Chrome  
14 Transistors — A Powerhouse of Quality Reception with AFC Operates on 4 "C" Cells  
22" Telescoping FM Antenna & Personal Listening attachment  
Money refund — if not better than any Known Brand selling for even twice the price  
8" x 5 1/4" x 2 1/4" — 4 lbs  
FREE — extra set of batteries

COMPLETE . . . \$19.50

**IBM COMPUTER SECTIONS**  
8 assorted Units we sell for \$1 are loaded with over 150 valuable parts.  
Incl. — Transistors, Condensers, Resistors, Heat Sinks, Diodes, Etc.

8 for \$1  
100 for \$10

- |   |   |   |   |
|---|---|---|---|
| <input type="checkbox"/> 1000—ASST. HARDWARE KIT \$1<br>screws, nuts, washers, rivets, etc. | <input type="checkbox"/> 20—FEDERAL SELENIUM RECTIFIERS new Tubular Type #15A2HS1                         | <input type="checkbox"/> 100—ASST 1/4 WATT RESISTORS \$1<br>stand. choice ohmages, some in 5%   | <input type="checkbox"/> 4—50' HANKS HOOK-UP WIRE \$1<br>assorted colors  |
| <input type="checkbox"/> 300 — ASSORTED HEX NUTS \$1<br>2/50, 4/40, 5/40, 6/32, 8/32 ..     | <input type="checkbox"/> 3—ELECTROLYTIC CONDENSERS \$1<br>most popular number 50/30—150v                  | <input type="checkbox"/> 100 — ASST 1/2 WATT RESISTORS \$1<br>stand. choice ohmages, some in 5% | <input type="checkbox"/> HOOK-UP WIRE #20 blue or red \$1<br>1000'-\$4 500'-\$2 200'-                                   |
| <input type="checkbox"/> 250—ASST. SOLDERING LUGS \$1<br>best types and sizes               | <input type="checkbox"/> 3—TOP BRAND SILICON RECTIFIERS 1 amp, 1000 PIV                                   | <input type="checkbox"/> 70 — ASST 1 WATT RESISTORS \$1<br>stand. choice ohmages, some in 5%    | <input type="checkbox"/> HOOK-UP WIRE #18 candystripe \$1<br>100'-\$6 500'-\$3 150'-                                    |
| <input type="checkbox"/> 250—ASST. WOOD SCREWS \$1<br>finest popular selection              | <input type="checkbox"/> 15 — G.E. #NE-2 TUBES \$1<br>Neon Glow Lamp for 101 uses ..                      | <input type="checkbox"/> 35 — ASST 2 WATT RESISTORS \$1<br>stand. choice ohmages, some in 5%    | <input type="checkbox"/> HOOK-UP WIRE #16 candystripe \$1<br>1000'-\$7 500'-\$4 100'-                                   |
| <input type="checkbox"/> 250 — ASST. SELF TAPPING SCREWS #6, #8, etc.                       | <input type="checkbox"/> CLEAN UP THE KITCHEN "JACK-POT" Big Deal \$1<br>only one to a customer           | <input type="checkbox"/> 50 — PRECISION RESISTORS \$1<br>asst. list-price \$50 less 98% ..      | <input type="checkbox"/> DELUXE ELECTRIC ZIP CORD \$2<br>2-conductor, ivory or brown, 500'-\$9 250'-\$5 100'-           |
| <input type="checkbox"/> 150—ASST. 6/32 SCREWS and 150 6/32 HEX NUTS                        | <input type="checkbox"/> HEARING AID AMPLIFIER \$2<br>incl. 3 Tubes, Mike, etc. (as is)                   | <input type="checkbox"/> 20 — ASST'ED WIREWOUND RESISTORS, 5, 10, 20 watt                       | <input type="checkbox"/> MINIATURE ZIP CORD 2 cond. transparent, for speakers, etc. \$1.39<br>1000'-\$11 500'-\$6 100'- |
| <input type="checkbox"/> 150—ASST. 8/32 SCREWS and 150—8/32 HEX NUTS                        | <input type="checkbox"/> CHAPT ZU DI MITZIA "JACK-POT" double your money back if not completely satisfied | <input type="checkbox"/> 100 — ASST. MICA CONDENSERS some in 5%                                 | <input type="checkbox"/> TV TWIN LEAD-IN 300 ohm \$1<br>500'-\$7 100'-\$1.50 50'-                                       |
| <input type="checkbox"/> 150—ASST. 2/56 SCREWS and 150—2/56 HEX NUTS                        | <input type="checkbox"/> 50 — ASST. TERMINAL STRIPS all types, 1-lug to 6-lug                             | <input type="checkbox"/> TELEPHONE RECORDING DEVICE instant suction cup fit                     | <input type="checkbox"/> CO-AX CABLE RG59U grey or black \$2<br>250'-\$9 100'-\$3.00 50'-                               |
| <input type="checkbox"/> 150—ASST. 4/40 SCREWS and 150—4/40 HEX NUTS                        | <input type="checkbox"/> 25 — INSTRUMENT POINTER KNOBS selected popular types                             | <input type="checkbox"/> 25' — MICROPHONE CABLE deluxe, 2 conductor, shielded                   | <input type="checkbox"/> TAPE RECORDER — assorted types good, bad, broken, as-is, potluck \$4                           |
| <input type="checkbox"/> 150—ASST. 5/40 SCREWS and 150—5/40 HEX NUTS                        | <input type="checkbox"/> 5 — I.F. COIL TRANSFORMERS sub-min for Transistor Radios                         | <input type="checkbox"/> \$15.00 RADIO PARTS "JACK-POT" handy assortment                        | <input type="checkbox"/> MICROPHONE RADIO asst type \$1.50<br>good, bad, broken, as-is, potluck                         |
| <input type="checkbox"/> 500—ASSORTED RIVETS most useful selected sizes                     | <input type="checkbox"/> 5 — AUDIO OUTPUT TRANSFORM Sub-min for Trans Radios                              | <input type="checkbox"/> 5 — PNP TRANSISTORS general purpose, TO-5 case                         | <input type="checkbox"/> 50 — TUBE CARTONS (colored) assorted sizes for Popular Tubes or—50 of any size you select      |
| <input type="checkbox"/> 500—ASSORTED WASHERS most useful selected sizes                    | <input type="checkbox"/> 4 — TOGGLE SWITCHES SPST, DPST, DPDT   | <input type="checkbox"/> 5 — NPN TRANSISTORS general purpose, TO-5 case                         | <input type="checkbox"/> 10 — ASSORTED TUBES Radio, Television and Industrial   |
| <input type="checkbox"/> 100—ASST. RUBBER BUMPERS for cabinet bottoms & other uses          | <input type="checkbox"/> 32'—TEST PROD WIRE deluxe quality, red or black                                  | <input type="checkbox"/> 15 — ASST. ROTARY SWITCHES all popular types \$20 value                | <input type="checkbox"/> ALL AMERICAN TUBE KIT Top Standard Brand — 12BA6, 12BE6, 12AV6, 50C5, 35W4                     |

MERCHANDISE WANTED in any quantity — TUBES (all types) — RADIO & TV PARTS — EQUIPMENT finished or unfinished — immediate cash. Please send samples, quotes & amounts — only new merchandise bought.

# Look What's NEW In The

**NEW! Deluxe Solid-State Combo Amplifier & Speaker System!**

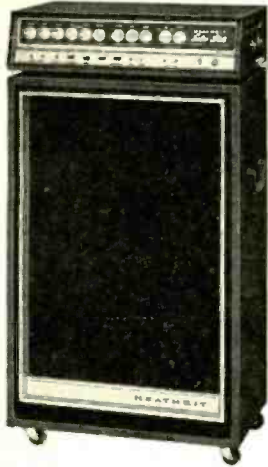

**Special Combo Offer!**

Kit TAS-17-2 Amplifier & 2 Speaker Systems

Save \$20.00  
**\$395<sup>00</sup>**

240 lbs.

All the "big sound" features every combo wants . . . tremolo, built-in "fuzz", brightness, reverb plus a shattering 120 watts of EIA music power. Has 3 independent input channels each with 2 input jacks. Handles lead or bass guitars, combo organ, singer's mike, even a record changer. Speaker system features two special 12" woofers, special horn driver and matching black vinyl-covered wood cabinet.

Kit TA-17 Amplifier  
**\$175<sup>00</sup>**

Kit TA-17-1 Speaker System  
**\$120<sup>00</sup>**

**NEW! Low Cost Single-Channel Solid-State Guitar Amplifier**



Kit TA-27  
**\$89<sup>95</sup>**

Assembled TAW-27  
**\$134<sup>95</sup>**

Boasts 20 watts EIA music power, 40 watts peak power; variable tremolo & reverb; two inputs that handle lead guitars; singer's mike; special heavy-duty 12" speaker; line bypass reversing switch that reduces hum; transformer-operated power supply; and handsome leather-textured, black vinyl covered wood cabinet with extruded aluminum front panel and chrome knobs. 35 lbs.

**NOW Available Fully Assembled . . . Heathkit "Starmaker" Dual-Channel Guitar Amplifier**



Assembled TAW-16  
**\$199<sup>95</sup>**  
(Kit TA-16 \$134.95)

Features all solid-state circuit; 25 watts EIA, 60 watts peak power; two channels, one for accompaniment, accordion or mike, the other for variable tremolo & reverb; two inputs each channel; two 12" heavy-duty speakers; line bypass reversing switch for hum reduction; leather-textured black vinyl covered wood cabinet with extruded aluminum front panel & chrome knobs. For extra savings, build the kit version in just 15 hours. 52 lbs.

**NOW Available Fully Assembled . . . World's Most Advanced Stereo Receiver!**



Assembled ARW-15  
**\$499<sup>50</sup>** Kit AR-15, \$329.95  
(less cab.)

Acclaimed by owners & audio experts for its advanced features like integrated circuits and crystal filters in the IF amplifier section; ultra-sensitive FET FM tuner; 150 watts dynamic music power; complete AM, FM and FM stereo listening; positive circuit protection; all-silicon transistors; "black magic" panel lighting; stereo only switch; adjustable phase control for best stereo and many more. 34 lbs. Optional wrap-around walnut cabinet \$19.95.

**NEW! Low Cost Solid-State FM Stereo Receiver**

Kit AR-17  
**\$72<sup>95</sup>**  
(less cabinet)

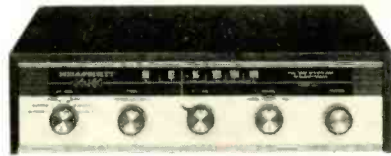

**NEW! Low Cost Solid-State FM Mono Receiver**

Kit AR-27  
**\$49<sup>95</sup>**  
(less cabinet)

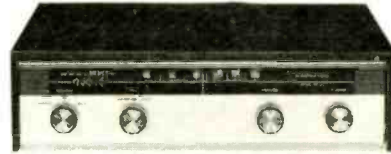

AR-17 FM Stereo Receiver features cool all-transistor circuit; 14 watts music power; wide response 18 to 60,000 Hz,  $\pm 1$  db at full 5 watts continuous power per channel; 30 db separation; front panel controls; flywheel tuning; adjustable phase control for best stereo; stereo indicator; phono and auxiliary inputs; outputs for 4 through 16 ohm speakers; preassembled, prealigned "front-end"; fast, easy circuit board assembly. 12 lbs.

AR-27 FM Mono Receiver has same features as AR-17 except for FM mono only reception and 7 watts music power. 9 lbs. Optional walnut (7.95) or beige metal (3.50) cabinets available for both units.

**NEW! Heathkit Soldering Iron**



Kit GH-17  
**\$14<sup>95</sup>**

Ideal for kit-building or other electronic soldering jobs. Safe 6 volt, 25 watt GE midget iron with non-corroding tip. 3 heat ranges. Excellent heat recovery time. Quick warm-up . . . iron ready in 2 minutes. Protective metal cage. Build in an hour. 5 lbs.

**NEW! Professional 10-Band Shortwave Listener's Receiver**



Kit SB-310  
**\$249<sup>00</sup>** (SB-600 8 Ohm, 6" x 9" Speaker, \$18.95)

Covers 6 shortwave bands (49, 41, 31, 25, 19 & 16 meters) . . . 80, 40 & 20 meter ham bands . . . 11 meter CB. Includes 5 kHz crystal filter for AM, SSB and CW listening. Features selectivity that slices stations down to last kHz . . . no more guessing station identities; 11-tube circuit; crystal-controlled front-end for same rate tuning on all bands; prebuilt & aligned LMO; tuning dial to knob ratio 4 to 1; and many more deluxe SWL features. 2-tone green metal cabinet included. Optional crystal filters for optimum CW & SSB available. 20 lbs.

# '68 HEATHKIT® Catalog!

Introducing The Exciting New Look Of Heathkit Solid-State Instruments!

Now from Heath... the most exciting innovation in electronic instrumentation... new ultra-functional cabinet styling. These new Heathkit instruments feature a cabinet frame consisting of front and rear panels with side rails that completely support the component chassis independent of the top and bottom cabinet shells... allows complete freedom for assembly, checkout and calibration. You'll like the

clean bold panel & meter markings for easier reading... the easier-to-grasp knobs... the compact size... and the retractable carrying handles that are concealed in the side rails. The die-cast front panel bezel styled in chrome and black, the black side rails, and the special two-tone beige front panels and cabinet shells give these new instruments an appearance as up-to-date as their performance.

## NEW! Deluxe Solid-State Volt-Ohm Meter... Battery Plus Built-In AC Power

Features 8 DC and 8 AC voltage ranges from 0.5v to 1500 v. full scale; 7 ohmmeter ranges x1 (10 ohms center scale), x10, x100, x1k, x10k, x100k and x1 megohm; 11 megohm input resistance on DC ranges; 1 megohm on AC ranges; internal battery or 120/240 v., 50/60 Hz AC power for portable or "in-shop" operation; large, easy-to-read 6" 100 uA meter; separate switches for individual functions; single test probe with finger-tip flip switch for all measurements; simple circuit board construction.

## Solid-State High Impedance Volt-Ohm-Milliammeter

All silicon transistors plus FET's. Features 9 AC and 9 DC voltage full scale ranges down to 150 mv; 11 current ranges from 15 uA to 1.5A full scale; 7 resistance ranges (10 ohms center scale) measure one ohm to 1000 megohms; AC plus battery power for portability; 6" 200 uA meter with zero center scale for + & - voltage measurements without switching; accuracy of ± 3% full scale on DC volts, ± 5% on AC volts; separate range switches for each function; 1% precision resistors; 10-turn thumbwheel zero adjustment; fast circuit board construction. 10 lbs.

## New FM Stereo Generator For RF, IF and FM Stereo Alignment

Produces virtually all signals for trouble-shooting & aligning multiplex adapters, FM tuners and receivers. Generates mono FM or composite stereo FM signals. Crystal-controlled 19 kHz (± 2 Hz) pilot signal, adjustable from 0 to 10% for checking tuner lock-in range. Switch-selection of 400 Hz, 1000 Hz, 5000 Hz, 19 kHz, and 65 kHz or 67 kHz SCA signals for complete alignment capability. 100 MHz sweep signal (adjustable ± 2 MHz) for overall RF and IF alignment. Built-in crystal controlled marker oscillator for IF and dial tracking checks. Phase test capability. No balance adjustment needed for equal right and left channel modulation levels.

## New Variable Regulated High Voltage Power Supply

Features 6v. and 12 v. AC filament voltages; also furnishes B+ from 0 to 400 volts DC, bias from 0 to -100 volts DC; separate panel meters monitor B+ output voltage & current; voltmeter switched to read C- volts; output terminals isolated for safety; high voltage and bias may be switched "off" with filaments still "on" for maximum testing efficiency and safety.

## New Solid-State Regulated Low Voltage Power Supply

New Zener reference-voltage power supply. New up-dated circuit that is virtually immune to overload from exotic transients. Relay-protected against short circuit & overload. Provides 0.5 to 50 volts DC with better than ± 15 millivolts regulation. 4 current ranges: 50 mA, 150 mA, 500 mA & 1.5 A. Adjustable current limiter: 30 to 100% on all ranges. Panel meter shows output voltage or current. Choice of kit or assembled versions.

Kit IM-16  
**\$44<sup>95</sup>**

Kit IM-25  
**\$80<sup>00</sup>**  
Wired IMW-25  
\$115.00

Kit IG-37  
**\$79<sup>95</sup>**

Kit IP-17  
**\$59<sup>95</sup>**

Kit IP-27  
**\$76<sup>95</sup>**  
Wired IPW-27  
\$119.95



**NEW**

**FREE 1968 CATALOG!**

Now with more kits, more color. Fully describes these along with over 300 kits for stereo/hi-fi, color TV, electronic organs, electric guitar & amplifier, amateur radio, marine, educational, CB, home & hobby. Mail coupon or write Heath Company, Benton Harbor, Michigan 49022.



HEATH COMPANY, Dept. 20 10  
Benton Harbor, Michigan 49022  
In Canada, Daystrom Ltd.

Enclosed is \$ \_\_\_\_\_, including shipping.

Please send model (s) \_\_\_\_\_

Please send FREE Heathkit Catalog.

Name \_\_\_\_\_

Address \_\_\_\_\_

City \_\_\_\_\_

State \_\_\_\_\_

Zip \_\_\_\_\_

Prices & specifications subject to change without notice.

CL-301

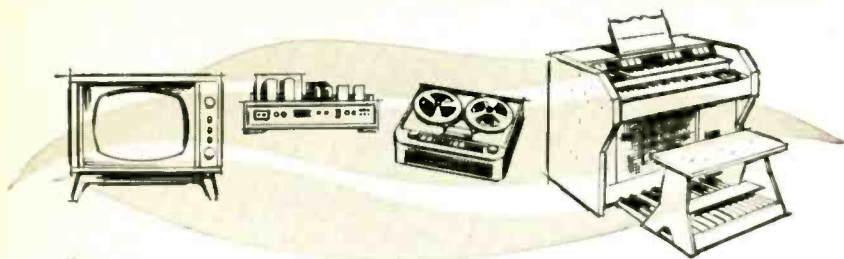

give your  
**COLOR-TV &  
 HI-FI STEREO**  
 heat problems  
 the **AIR**



only  
**\$14.85**  
 complete

install a DELWYN

*Whisper Fan*®

Everyday, everywhere, fans are at work cooling billions of dollars worth of electronic equipment in computers, missile and airborne electronics. Now, you can have this same kind of proven protection in your home electronic equipment. You need never miss your favorite TV program or the music you want because of heat-caused part failures.

Quickly and easily installed, no extra hardware needed, the Delwyn Whisper Fan keeps a steady stream of fresh cool air circulating over all heat generating components.

Use a Delwyn Whisper Fan in your Color-TV, Hi-Fi Stereo, electronic organ, tape recorder and other home electronic equipment. Guard against costly repair bills — add years of service-free life to your home entertainment equipment.

See your local dealer for a convincing demonstration. The Delwyn Whisper Fan is aerodynamically designed by Rotron, the world's leading supplier of cooling devices for electronic equipment.



**DELWYN**™

Box 195 B, Route 28  
 Kingston, New York 12401

Circle 124 on reader's service card

**BUILD—HOME MOVIES  
 TIME-COMPRESSION MACHINE**

*continued from page 43*

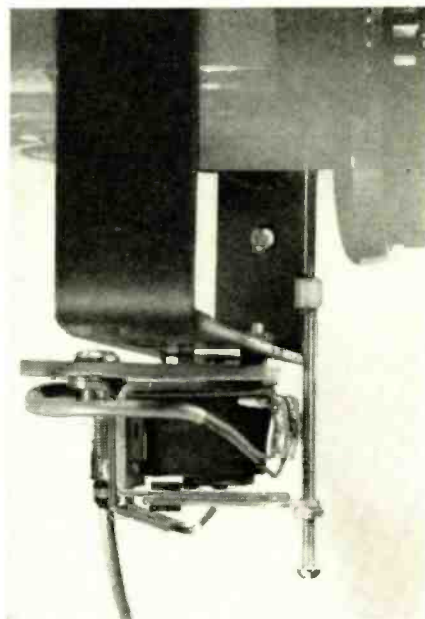

*Fig. 8—Relay and extension arm mounted ready to trigger a spring-drive camera.*

ber of seconds) on the panel and then turn R3 slightly counterclockwise to a point where another desired interval is obtained. Continue this process until the scale is completely marked (R3 fully counterclockwise). Also adjust the machine-screw linkage (Fig. 8) along with the contact arm stop until proper action occurs. (The camera shutter should trip when the solenoid energizes, and release when the solenoid de-energizes.) Once the contact arm is adjusted properly, it should never have to be readjusted. You should adjust the linkage for as little travel as possible to trip the shutter release. Average travel required is usually  $\frac{1}{16}$ ".

**Operation**

When you try time-lapse filming, be certain the camera is mounted on a sturdy tripod and don't disturb it during the filming. To film a sunset, for example, set the Pulser interval for 2 seconds. Turn on the unit approximately 15 minutes before the sun sets and continue running until just after it sets. On the screen, the 15 minutes of sunset will last 30 seconds. **R-E**

**MISS-Q**

In the "Wanted: Test Instrument Info," article (July, 1967), change the letter "D" to letter "C" in the 3rd column on page 52 for Hickok's Tube Tester, model 6000A. This tube tester is a current model.



# Now There Are 3 Heathkit® Color TV's To Choose From

## Introducing The NEW Deluxe Heathkit "227" Color TV

**Exclusive Heathkit Self-Servicing Features.** Like the famous Heathkit "295" and "180" color TV's, the new Heathkit "227" features a built-in dot generator plus full color photos and simple instructions so you can set-up, converge and maintain the best color pictures at all times. Add to this the detailed trouble-shooting charts in the manual, and you put an end to costly TV service calls for periodic picture convergence and minor repairs. No other brand of color TV has this money-saving self-servicing feature.

**Advanced Performance Features.** Boasts new RCA Perma-Chrome picture tube with 227 sq. in. rectangular viewing area for 40% brighter pictures . . . 24,000 v. regulated picture power and improved "rare earth" phosphors for more brilliant, livelier colors . . . new improved low voltage power supply with boosted B+ for best operation . . . automatic de-gaussing combined with exclusive Heath Magna-Shield that "cleans" the picture every-time you turn the set on from a "cold" start, and keeps colors pure and clean regardless of set movement or placement . . . automatic color control and gated automatic gain control to reduce color fade and insure steady, flutter-free pictures even under adverse conditions . . . preassembled & aligned 3-stage IF . . . preassembled & aligned 2-speed transistor UHF tuner and deluxe VHF turret tuner with "memory" fine tuning . . . 300 & 75 ohm VHF antenna inputs . . . two hi-fi sound outputs . . . 4" x 6" 8 ohm speaker . . . one-piece mask & control panel for simple installation in a wall, your custom cabinet or either optional Heath factory-assembled cabinets. Build in 25 hours.

**GRA-227-1**, Walnut cabinet . . . . . \$59.95  
**GRA-227-2**, Mediterranean Oak cabinet (shown above) . . . \$94.50



Kit GR-227  
**\$399<sup>95</sup>**  
 (less cabinet)

Kit GRA-27  
**\$19<sup>95</sup>**



### New Remote Control For Heathkit Color TV

Now change channels and turn your Heathkit color TV off and on from the comfort of your armchair with this new remote control kit. Use with Heathkit GR-227, GR-295 and GR-180 color TV's. Includes 20' cable.



Kit GR-295  
**\$479<sup>95</sup>**  
 (less cabinet)

### Deluxe Heathkit "295" Color TV

Has same high performance features and built-in servicing facilities as new GR-227, except for 295 sq. in. viewing area (industry's largest picture) . . . 25,000 volt picture power . . . universal main control panel for versatile in-wall installation . . . and 6" x 9" speaker.

**GRA-295-1**, Walnut cabinet (illust. above) . . . . . \$62.95  
**GRA-295-3**, Early American cabinet . . . . . \$99.95  
**GRA-295-2**, Deluxe walnut cabinet . . . . . \$94.50



Kit GR-180  
**\$349<sup>95</sup>**  
 (less cabinet)

### Deluxe Heathkit "180" Color TV

Same high performance features and exclusive self-servicing facilities as new GR-227 (above) except for 180 sq. in. viewing area.

**GRA-180-1**, Contemporary walnut cabinet . . . . . \$49.95  
**GRA-180-2**, Early American cabinet . . . . . \$75.00  
**GRA-180-3**, Table model cabinet . . . . . \$24.95  
**GRA-180-5**, Table model cabinet & mobile cart (illust. above) . . . . . \$39.95



## NEW FREE 1968 CATALOG!

Now with more kits, more color. Fully describes these along with over 300 kits for stereo/hi-fi, color TV, electronic organs, electric guitar & amplifier, amateur radio, marine, educational, CB, home & hobby. Mail coupon or write Heath Company, Benton Harbor, Michigan 49022.

HEATH COMPANY, Dept. 20-10  
 Benton Harbor, Michigan 49022  
 In Canada, Daystrom Ltd.



Enclosed is \$ \_\_\_\_\_, including shipping.

Please send model (s) \_\_\_\_\_

Please send FREE Heathkit Catalog.

Name \_\_\_\_\_

Address \_\_\_\_\_

City \_\_\_\_\_

State \_\_\_\_\_

Zip \_\_\_\_\_

Prices & specifications subject to change without notice.

CL-306

# RCA announces 2 new color-TV test jigs

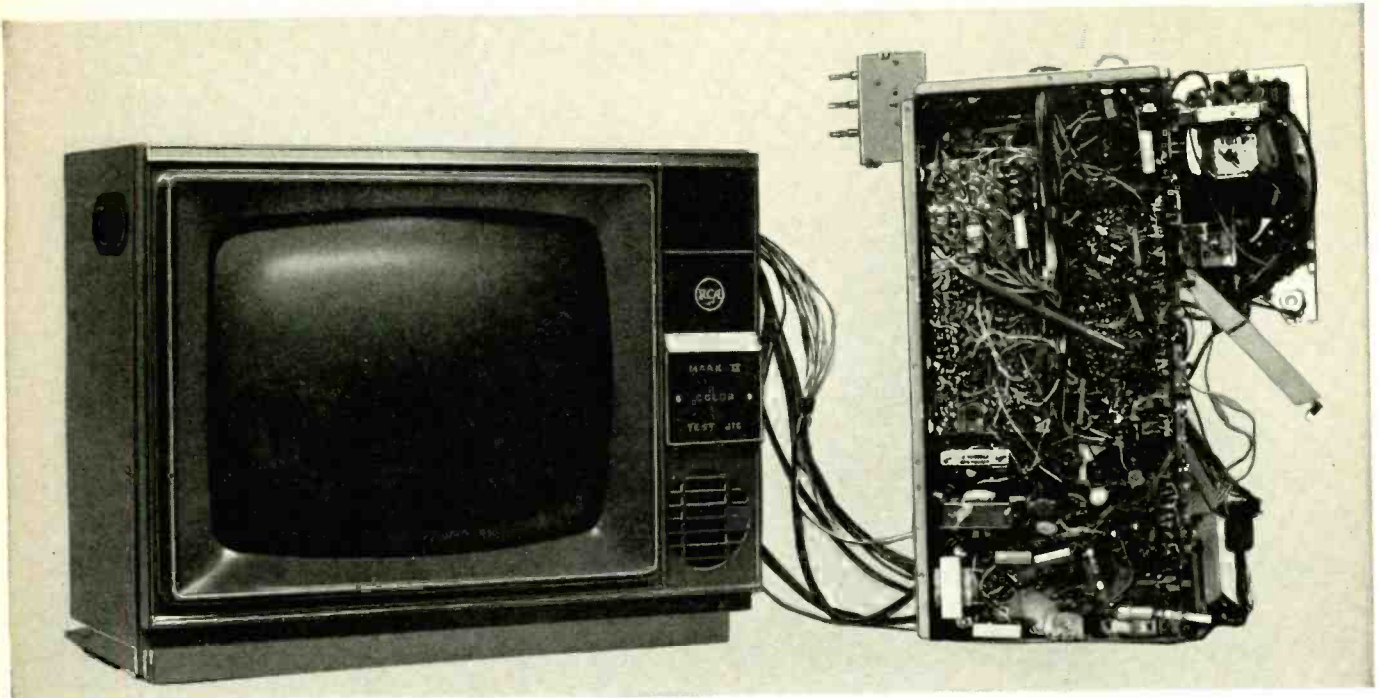

## New RCA MARK II

■ **IDEAL** for servicing all the RCA 90° rectangular receiver chassis (18" diagonal and larger) and RCA 70° round (21") receiver chassis made within last 10 years.

■ **COMPACT** in size, weight and price. 30% smaller and less than half the weight of former models.

### ■ PACKED WITH NEW FEATURES.

- ... Automatic degaussing assembly.
- ... Large padded hand holds double as side entry paths for servicing cables.
- ... Preassembled Kine neck components are ready to slip on and clamp in place.
- ... Rugged welded-steel cabinet, in rich hammeroid cobalt grey to match test equipment. Picture tube not included.

## New RCA MARK III



■ **PORTABLE**, for in-the-home chassis check, without removing chassis from cabinet.

■ **A SALES TOOL.** Lets you compare customer's picture tube with test jig picture tube performance.

■ **VERSATILE.** Use the Mark III with all RCA 90° rectangular receiver chassis (18" diagonal and larger), and all RCA 70° round receiver chassis (21") made within last 10 years.

■ **INCLUDES** all Kine neck components—preassembled. Ready to slip on and clamp in place. Durable polyethylene cabinet. Picture tube not included.

*Put an RCA Mark II in your shop and an RCA Mark III in your truck. The combination will help you speed up job completions . . . and sales. See both of these outstanding color-TV test jigs at your RCA Distributor today.*

*RCA PARTS AND ACCESSORIES, Deptford, N.J.*



The Most Trusted Name in Electronics

See the Perry Como Holiday Special in color on NBC-TV. Thursday, November 30. 7:30-8:30 P.M. EST.

## Transistor and Diode Mini Tester

continued from page 47

Silicon transistors, on the other hand, will show no perceptible leakage even on the LO scale.

After making this test for "leakage," you can check for gain. Simply depress the TEST button and rotate R1 slowly clockwise until the meter pointer is on the silver line. The direct-current gain of the transistor can then be read directly from R1's dial. Open transistors will pass little or no current and shorted or improperly connected transistors can show a runaway current characteristic.

To test the performance of a transistor as an audio amplifier, feed a small audio signal (about 1 mV or less) into J1, plug a crystal earphone into J2, and listen. Depress the TEST button and rotate R1 until you hear the loudest output without distortion. You should have no difficulty in identifying good and bad transistors in this manner. You may have to listen to some good and bad units to get the "hang" of it.

**Optimum Bias.** To determine the bias current flow while the transistor is working in the tester (at maximum volume without distortion) simply compare the gain figure indicated by the position of R1, with the Emitter-Base Current tabulation in the Calibration Chart. You can simplify matters by marking the values of current directly on R1's dial, along with the gain markings.

Diodes can be checked by connecting them to J2 and J4 and depressing the test pushbutton. When the tester is turned on and S4 is on HI, the meter will read full scale for a diode with good forward conductance. Next, slide S3 to its NPN position and read the diode's reverse current: it should be nearly zero for a good diode, with S4 set in its LO position.

Polarity of the diode and the initial position of S3 are not of any consequence for this test. Whether you get a high or a low reading the first time you hit the test button is not important. The important thing is that there be a big difference between forward and reverse current. The best diodes have a large front-to-back ratio and a small reverse current.

If you wish to identify the anode and cathode in the diode under test, simply note the position of S3 when you get a forward current reading. When S3 is in the npn position, the anode is connected to J4. **R-E**

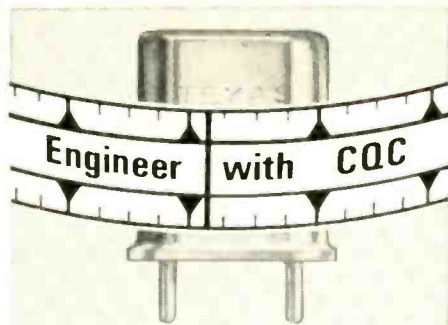

### MORE CONTROL

Control of quality throughout precision manufacturing gives you crystals that assure exact frequency control.

### MORE RELIABILITY

You'll stay on frequency better with CQC. And, you can rely on your CQC dealer to fill your needs promptly.

See your dealer for prices and data on CQC



## TEXAS CRYSTALS

Div. of Whitehall Electronics  
1000 Crystal Drive  
Fort Myers, Fla. 33901  
Plants in Fort Myers and Los Angeles

# FREE!

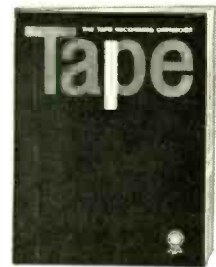

## Just Published

It's a regular mini-library on the care and affection of TAPE RECORDERS (How to select. What to look for. Performance factors.); TAPE (Tips on splicing, editing and handling.); MICROPHONES (How to select and use them.); and many other provocative and useful facts. Yours FREE.

Elpa Marketing Industries Inc.  
New Hyde Park, N. Y., 11040

Please send me FREE "The Tape Recording Omnibook". I'm interested in: \_\_\_\_\_  
A Tape Recorder \_\_\_\_\_ Editing Systems  
\_\_\_\_\_ Microphones

Name \_\_\_\_\_

Address \_\_\_\_\_

City/State/Zip \_\_\_\_\_

Circle 127 on reader's service card

**THE MODERN ELECTRONIC AUTO** isn't just around the corner—it's here! With solid-state alternator diodes and transistorized voltage regulators, etc. Find out the latest developments in the November issue.

# ELECTRONICS

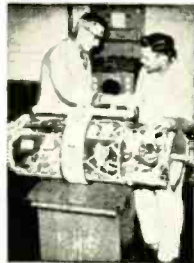

## Engineering-Technicians

**Bachelor of Science Degree, 30 Months**  
Save Two Years' Time

- Radio-Television Plus Color Technician (12 Months)
- Electronics Engineering Technology (15 Months)
- Electronics Engineering (B.S. Degree)
  - Electrical Engineering (B.S. Degree)
  - Mechanical Engineering (B.S. Degree)
  - Civil Engineering (B.S. Degree)
  - Architecture (B.S. Degree) (36 Months)

The Nation's increased demand for Engineers, Electronic Technicians, Radio TV Technicians is at an all time high. Heald Graduates are in demand for Preferred High Paying Salaries. Train now for a lucrative satisfying lifetime career.

Approved for Veterans

DAY AND EVENING CLASSES

Write for Catalog and Registration Application.  
New Term Starting Soon.

Your Name \_\_\_\_\_  
Address \_\_\_\_\_  
City \_\_\_\_\_  
State \_\_\_\_\_



1215 Van Ness Avenue  
San Francisco, California

Circle 128 on reader's service card

WE DON'T CLAIM  
OUR ELECTRONIC  
IGNITION SYSTEM  
IS BEST



OUR  
CUSTOMERS DO!

WRITE TODAY FOR FREE LITERATURE

**JUDSON**

RESEARCH AND MFG. CO.  
CONSHOHOCKEN, PA., U.S.A.

Circle 129 on reader's service card

# NOTEWORTHY CIRCUITS

## FIVE-CHANNEL TONE CONTROL

From time to time, readers ask for diagrams of multi-channel tone controls that can be added to PA, hi-fi and other audio equipment. Here is the circuit of a five-channel tone control unit that was described in *Funkschau* (Munich, Germany). Fig. 1 shows the right channel of the stereo unit. Channel 1 (top) is a low-pass circuit that begins to roll

off at around 60 Hz. Channels 2, 3 and 4 are band-pass circuits and channel 5 is a high-pass network. The overall response and the response curves of the individual networks are shown in Fig. 2. Maximum signal input is 1.5 volts and maximum output is 2.1 volts. Output impedance is 680 ohms, making the circuit ideal for driving almost anything. **R-E**

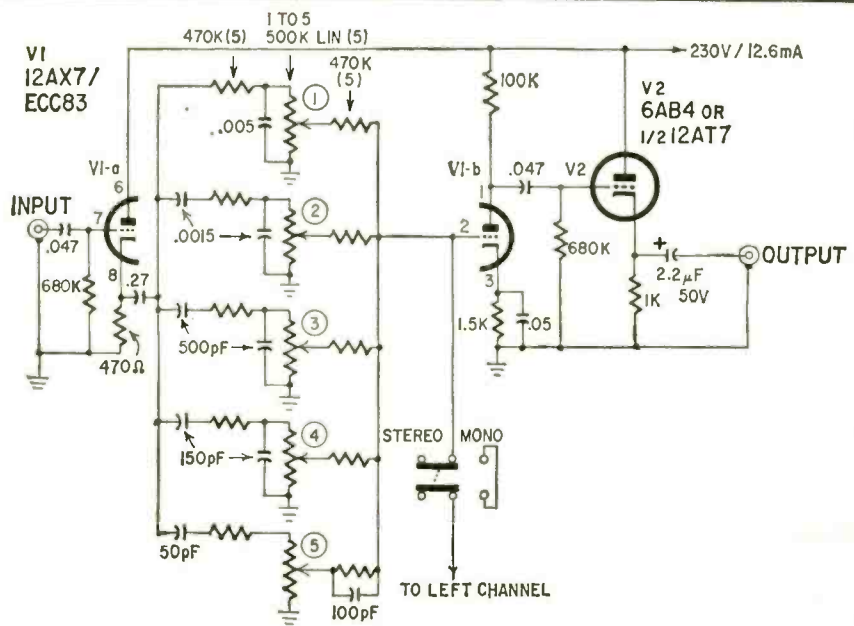

Fig. 1

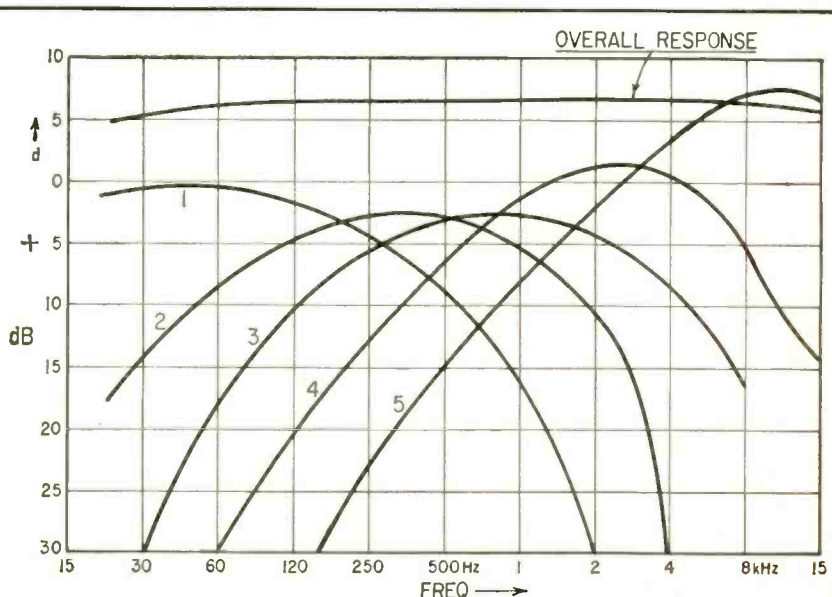

Fig. 2

## U.S. GOV'T ELECTRONIC SURPLUS

• Nationally Known - World Famous SURPLUS CENTER offers finest, most expensive, Government Surplus electronic units and components at a fraction of their original acquisition cost.

ORDER DIRECT FROM AD OR WRITE FOR CATALOGS

### STANDARD DIAL TELEPHONE

• (ITEM #715) - Standard, commercial telephone same as used throughout U.S.A. Attractive polished black, like new condition. Use as extension phone to private system or connect several phones together for local intercom system. Full instructions are furnished. Wt. 9 lbs. Original Cost \$24.50. **F.O.B. \$5.95**



### STEP-BY-STEP AUTOMATIC SWITCH

• (ITEM #738) - Amazing "up-and-around" electro-magnetic telephone switch. Dial any bank from 1 to 100. Make your own telephone system. Can also be used to remotely control up to 100 circuits over a single pair of wires.

• One of our FOUR NIVIC bargains. Comes complete with data, one dial and one line bank. Size: 5" x 7" x 1 1/2". Wt. 16 lbs. Cost Over \$75.00. Complete: Switch, cover, dial, 11m bank, instructions. **F.O.B. \$9.95**



### TYPICAL BUYS FROM OUR 1967 CATALOGS

- \$ 350.00 - Geared 2-hp Battery Golf Car Motor ..... **\$24.95**
- \$ 15.00 - Westinghouse DC Ammeter, 0 to 300..... **\$ 7.11**
- \$ 40.00 - Vacuum/Pressure Pump, 12-VDC ..... **\$11.95**
- - - 80-MW Walkie-Talkies, Per Pair ..... **\$19.60**
- - - Deluxe, Multi-Range, AC/DC Tester ..... **\$ 8.98**
- \$4000.00 - Carrier Telephone Amplifier System ..... **\$13.91**

### SPECIAL SALE

Correspondence  
Course in  
ELECTRICAL  
ENGINEERING



Sells For \$10.79 **\$8.79** Postpaid  
Outside U.S.A. In U.S.A.

• (ITEM #A101) - Wonderful chance to obtain technical training at Amazing Low Cost! Lincoln Engineering School has suspended its Correspondence Courses because of increased operating costs. We offer a limited number of the school's complete Electrical Engineering Course but without the examination paper grading service. The course consists of 14 lesson unit books, 9 each book has the regular exams, and in a separate section, "standard answers" to each exam question.

• Course is well written, easy to understand, brilliantly illustrated. Reader's Digest size, easy to carry and study in spare time. Many Lincoln Engineering School students holding excellent jobs as a result of E.E.S. training. Course contains latest information on transistors, silicon diodes, etc. Additional book on how to build and operate a "Home Laboratory and Experimental Bench" furnished with each course.

SEND 25c COIN OR STAMPS FOR 3 MAIN CATALOGS

All Items FOB Lincoln Money Back Guarantee

**SURPLUS CENTER**

DEPT. RE-107 LINCOLN, NEBR. 68501

Circle 130 on reader's service card

# TRY THIS ONE

## PREVENT TEST-LEAD SHORTING

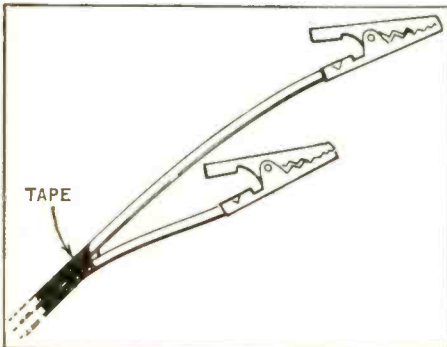

Test leads with alligator clips often become tangled and short together. A simple remedy is to tape the two wires together, so that one wire is longer than the other, just enough that if they do come together, they cannot short.

—Lee D. Fortun

## QUICK ROTATOR HARNESS

A simple rotator connecting harness can be made out of a scrap piece of rotator wire, four small alligator clips and four lugs. Solder the lugs on the four wires at one end of the cable; this end goes on the rotator box ter-

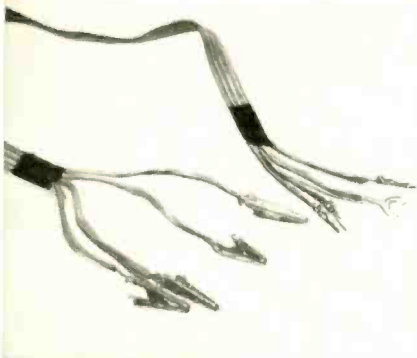

minals. The alligator clips clip to the motor terminals. Use the silver-colored wire as No. 1, the next wire as No. 2 and on down the line. It is easy to connect the two units and you don't have to twist and curl the wires around each terminal post.

—Homer L. Davidson

R-E

Because you've got to SEE it to BELIEVE it  
..... we will send you a FREE sample!

instant lettering®

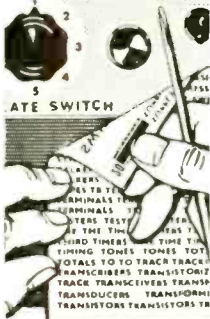

## DATAMARK

— the easy new way to label your projects!

Just rub over the pre-printed words or symbols with a ballpoint pen and they transfer to any surface — looks like finest printing! Label control panels, meter dials, letter on anything!

LOOK FOR instant lettering®

**DATAMARK SETS** only \$1.25 each — at leading electronic distributors

DATAMARK SETS AVAILABLE FOR:

- Amateur Radio. CB
- Audio, Hi-Fi, TV
- Experimenter Home Intercom
- Industrial Test Equipment
- Switch & Dial Markings
- Alphabets & Numerals in

1/8", 1/4" and 1/2"

— each set has black, white, and gold

SEND FOR FREE SAMPLE RE-107

**THE DATA CORPORATION**  
85 HIGHLAND AVENUE • PASSAIC, N. J. 07055

Circle 131 on reader's service card

## INTEGRATED CIRCUIT SALE

Quality at Crazy Prices

ICS TO-5/TO-46 RTL, Gates, Buffs., FFs, Adders etc with 8 hole test socket 100 asstd. \$10.95  
ICs, TO-85 Flatpacks DTL/RTL Some Plated include Auger Test Socket, 100 asstd. \$12.95  
Flatpacks, All Gold Plated w/socket, 100 \$15.95  
Half Packs of above, \$5.95, \$6.95 & \$8.50. (Less test socket. Extra test sockets, \$1.00 each)  
All ICs sample test over 50-80% good. Schematics, identification & test info. included.  
Hi-Gain (Darlington) Amplifier, TO-18 NPN. Similar 2N998 Tested \$7 for \$2.95  
Field Effect Trans. (FET) P channel Similar 2N3277 TO-5, tested \$4 for \$2.95, U-Test 10 for \$2.95  
Dual Trans. (Diff. Amplif) 6 lead choice TO-5/18 NPN/PNP, Sim. 2N2060 Tested 7 for \$2.95, U-Test \$50 for \$5.95, 100 for \$8.95, asstd.  
Microcleared Relay 3/8" sq x 1 1/4". Ax. leads. Norm. open 3000 ohm coil, pick on 6V 3 ma. 4 for \$2.95  
Memory Plane 5" x 8" with 4000 wired toroid bits . . . Perfect. \$9.75; Damaged plane . . . \$3.75  
Memory Plane 10" x 10" with 10,000 wired toroid bits, perfect \$15.00. Damaged plane . . . \$5.00  
Matrix Board 2" x 3" 100 wired toroids . . . \$2.00  
Memory Info. included, Add 1 lb. Postage.  
Nuvistors, #7895 with socket panel . . . 4 for \$2.95  
Lampdriver, SCR Module w 6-10V lamp. 4 for \$2.95  
Jumbo Silic. Trans. Asst. Over 1000 TO-5, 18, 46, 52, 66, 3, 4, 6, 8 lead devices includ. mostly Trans. duals, Darl. FETs, SCRs, ICs & power types & diodes. Sample test 50 to 90% good. Including Pomona Flare top test socket. Postage 3 lbs. \$19.50; Half Pack of above, less socket . . . \$9.95

Free Goody Bag with \$10 order (25¢ postage)

Add postage for heavy items, others ppd.

California orders 5% sales tax.

Catalog now ready. All mdsc. guaranteed

## MIKE QUINN ELECTRONICS

Bldg. 727 Langley Street  
Oakland Airport, Calif. 94614

Circle 132 on reader's service card

## SCHOOL DIRECTORY

Learn Electronics for your SPACE-AGE EDUCATION at the center of America's aerospace industry

No matter what your aerospace goal, you can get your training at Northrop Tech. in sunny Southern California.

**COLLEGE OF ENGINEERING.** Get your B.S. degree in engineering in just 36 months by attending classes year round. Most Northrop Tech graduates have a job waiting for them the day they're graduated!

**A & P SCHOOL.** Practical experience on real aircraft. One-year course prepares you for F. A. A. A & P certificate. **WRITE TODAY FOR CATALOG.**

**NORTHROP INSTITUTE OF TECHNOLOGY**  
1199 W. Arbor Vitae, Inglewood, Calif.

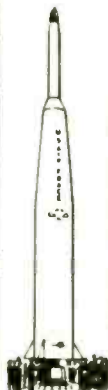

for a professional career

Tri-State graduates hold important engineering and business administration posts throughout the U. S. This professionally-oriented small college has outstanding placement record. Four-quarter year permits degree in three years. Excellent faculty. Well-equipped labs. Beautiful 300-acre campus. Accredited. Small classes. Modest costs. One-year Drafting-Design Certificate program. Enter Jan., March, June, Sept. For Catalog, Write Director Admissions Indicating career interest.

**TRI-STATE COLLEGE**  
24107 College Avenue, Angola, Indiana 46703

## GET INTO ELECTRONICS

V.T.I. training leads to success as technicians, field engineers, specialists in communications, guided missiles, computers, radar and automation. Basic & advanced courses in theory & laboratory. Electronic Engineering Technology and Electronic Technology curricula both available. Assoc. degree in 29 mox. B.S. also obtainable. G.I. approved. Graduates in all branches of electronics with major companies. Start Feb., Sept. Dorms, campus. High school graduate or equivalent. Catalog.

**VALPARAISO TECHNICAL INSTITUTE**  
Department C, Valparaiso, Indiana



## ENGINEERING MATHEMATICS

**NOW! A NEW WAY TO LEARN—I. H. S. I. WAY.** A complete home study course in engineering math to help you get the position you want—**MORE MONEY—MORE RESPECT.**

**COURSE PREPARED BY COLLEGE PROFESSORS** who have lectured to thousands of men on math and engineering. You learn at home quickly, easily—**AS FAST** as you want.

**YOU SIGN NO CONTRACTS** Pay only if satisfied—you owe it to yourself to examine the **INDIANA HOME STUDY INSTITUTE COURSE IN ENGINEERING MATH.**

**FREE BONUS**—if you join now, a refresher course in basic arithmetic.

Write for Brochure—No Obligation.

**THE INDIANA HOME STUDY INSTITUTE**  
Dept. RE-10, P.O. Box 1189  
Panama City, Fla. 32401

Let **COYNE** Train You **AT HOME** for Big Pay in **TELEVISION RADIO COLOR TV**

## TELEVISION RADIO COLOR TV

MAIL COUPON FOR FREE BOOK

Coyne Electronics Institute Dept. 77-C5  
1501 W. Congress Pkwy., Chicago, Ill. 60607  
Send FREE Book showing how I can get Coyne Quality Home Training in TV-Radio at Low Cost on Easy Terms.

Name.....  
Address.....  
City..... State..... Zip.....  
Phone..... Age.....

Put X here if Interested in Resident School for Associate Degree in Electronics Engineering and Technology, or shorter courses in Electricity, Radio-TV, Electronics. Approved GI Bill. Spare time employment and tuition payment plans available.

# MARKET CENTER

## GENERAL

CONVERT ANY TELEVISION to sensitive Big-Screen Oscilloscope. Only minor changes required. No electronic experience necessary. Illustrated plans \$2.00. RELCO-A25, Box 10563, Houston 18, Texas

TV SERVICE ORDER BOOKS for use with your rubber stamp. Duplicate or triplicate. Low cost. Write for FREE 32 PAGE CATALOG and Special Rubber Stamp Offer. OELRICH PUBLICATIONS, 6556 W. Higgins, Chicago, Ill. 60656

FREE ELECTRONICS (new and surplus) Parts catalog. We repair multimeters. BIGELOW ELECTRONICS, Bluffton, Ohio 45817

**88-108 MC F.M. RECEIVER**  
 10 TUBE CRYSTAL CONTROLLED F.M. RECEIVER WITH TUBES VOLUME TONE CONTROLS 4 WATT OUTPUT. 115 V 60 CYCLE. METAL CABINET 8H x 10D x 12W. WITH DIAGRAM LESS CRYSTAL AND SPEAKER. REMOVED FROM SERVICE BY STORECAST OUTFIT THAT WENT SOLID STATE. \$14.50 EA: 2 for \$25.00 PLUS SHIPPING.  
 LEED'S RADIO, 57 WARREN ST., N.Y.C. 10007

**TREASURE HUNTERS! PROSPECTORS!** Relco's new instruments detect buried gold, silver, coins. Kits, assembled models. Transistorized. Weighs 3 pounds, \$19.95 up. Free catalog. RELCO-A25, Box 10839, Houston, Texas 77018

**BACK-ISSUES**, Electronic, Scientific Magazines. SEMCO, Box 130, Roxboro, Quebec, Canada

**MAGNETS**. All types. MARYLAND MAGNET COMPANY, 5412-G Gist Avenue, Baltimore, Md. 21215

## WANTED

QUICK CASH . . . for Electronic EQUIPMENT, COMPONENTS, unused TUBES. Send list now! BARRY, 512 Broadway, New York, N. Y. 10012, 212 WALKER 5-7000

## FREE ARCTURUS CATALOG

*A Trusted name in Electronics Since 1925*  
*Electronic parts, tubes. Wholesale.*  
*Thousands of items. Unbeatable prices.*  
**ARCTURUS ELECTRONICS CO.**  
 502-22nd St., Dept. RE, Union City, N. J. 07087

## ALL OUR TRANSISTORS & RECTIFIERS ARE GUARANTEED TO WORK.

All our transistors are checked for voltage & gain to insure our customers a good transistor within the category we advertise. We will stand on our reputation for quality devices and service.

Our semiconductors have full factory length leads, are American made, unused, and in good physical condition. Our technical descriptions and pictures are accurate.

### 1 AMP Top Hat & Epoxy

PRV	AMP
100	.07
200	.09
400	.12
600	.18
800	.22

PRV	AMP
1000	.35
1200	.50
1400	.65
1600	.80
1800	.90

- 10 WATT ZENERS. 3-200V. State desired voltages Ea. \$.75
- 50 WATT ZENERS. 6-200V. State desired voltages . . . \$1.75
- SILICON BILATERAL SWITCH. Replaces two SCR's by firing in either direction when breakdown voltage is exceeded. Used in light dimmers, etc. . . . 2/\$1.00
- 1000 PRV at 3A full wave bridge . . . \$3.50
- NEON LIGHT of NIXIE TUBE DRIVERS. An NPN, TO-18, Si Transistor with a V<sub>CEO</sub> of 100 3/\$1.00
- SIM. to 2N2875 (PNP). Silicon 20 watts with 30 MHz cut off \$.75
- HIGH-VOLTAGE NPN 150V VBCBO at 2.5A, hi gain in TO-66 pack . . . \$ .75

### Silicon Power Rectifiers

PRV	3A	12A	20A	40A
100	.09	.30	.40	.75
200	.16	.50	.60	1.25
400	.20	.70	.80	1.50
600	.30	1.00	1.20	1.80
800	.40	1.25	1.50	2.30
1000	.55	1.50	1.80	2.70

## TRIACS

TO-66  
5 AMPS

PRV	
100	.90
200	1.40
300	1.75
400	2.25
500	2.60

## MORE INTEGRATED CIRCUITS



- SR FLIP FLOPS . . . . . \$ .90
- JK FLIP FLOPS . . . . . \$1.15
- DUAL NAND NOR GATES . . . \$1.00
- SR CLOCKED FLIP FLOPS . . \$1.15
- SRT FLIP FLOPS . . . . . \$1.15
- OR EXPANDERS . . . . . \$1.00
- DUAL AND GATE . . . . . \$1.00
- QUAD NAND NOR GATES . . . \$1.00

TO-85 flat pack with holder. Guaranteed to work. They come complete with schematic, elect. characteristic sheet and some typical applications.



### Silicon Control Rectifiers TO-66 pack Studs

PRV	3A	7A	20A
50	.35	.45	.70
100	.50	.65	1.00
200	.70	.95	1.30
300	.90	1.25	1.70
400	1.20	1.60	2.10
500	1.50	2.00	2.50
600	1.80	2.40	
700	2.20	2.80	
1000		4.00	

POST OFFICE BOX 74 D  
SOMERVILLE, MASS. 02143

Send For Our Fall Catalog Featuring Transistors, Rectifiers And Components

Circle 141 on reader's service card

Terms: FOB Cambridge, Mass. Send check or Money Order. Include Postage, Average Wt. per package 1/2 lb. Allow for C.O.D. Minimum Order \$3.00

# ADVERTISING INDEX

RADIO-ELECTRONICS does not assume responsibility for any errors which may appear in the index below.

Allied Radio Corp. . . . .	68
Arrow Fastener Co., Inc. . . . .	79
Artisan Organs . . . . .	78
Barker Products Co. (Audio Division of Component Manufacturing Service, Inc.) . . . . .	58
Blonder-Tongue . . . . .	4
Brooks Radio & TV Corp. . . . .	84-85
Burstein-Applebee Co. . . . .	70
Capitol Radio Engineering Institute, The . . . . .	28-31
Castle TV Tuner Service, Inc. . . . .	78
<b>CLASSIFIED . . . . .</b>	<b>96-99</b>
Cleveland Institute of Electronics . . . . .	13, 62-65
Conar (Div. of National Radio Institute) . . . . .	85
Cornell Electronics Co. . . . .	97
Datak Corporation, The . . . . .	95
Delta Products, Inc. . . . .	80
Delwyn . . . . .	90
DeVry Institute of Technology (A Subsidiary of Bell & Howell) . . . . .	5
EICO Electronic Instrument Co., Inc. Third Cover Electro-Voice, Inc. . . . .	23
Electronic Measurement Corp. (EMC) . . . . .	70
Elpa Marketing Industries Inc. . . . .	93
Fair Radio Sales . . . . .	81
Finney Co. . . . .	60-61
Garrard (British Industries Corp.) . . . . .	2
GC Electronics Company . . . . .	67
Grantham School of Electronics . . . . .	1
Great Lakes Insurance Co. . . . .	85
Heald Engineering College . . . . .	93
Heath Company . . . . .	86-89, 91
Hickok Electrical Instrument Co. . . . .	22
International Crystal Mfg. Co., Inc. . . . .	100
Irish Magnetic Recording Tape . . . . .	81
Jerrold Electronics Corporation (Distributor Sales Division) . . . . .	27
JFD Electronics Corp. . . . .	71
Judson Research and Mfg. Co. . . . .	94
Lafayette Radio Electronics Company . . . . .	82
Mallory Distributor Products Company (Div. of P. R. Mallory & Co., Inc.) . . . . .	7
Mike Quinn Electronics . . . . .	95
Multicore Sales Corp. . . . .	84
Music Associated . . . . .	78
National Radio Institute . . . . .	8-11
Olson Electronics, Inc. . . . .	79
Oxford Transducer Company (A Division of Oxford Electric Corporation) . . . . .	6
Perma-Power Company . . . . .	81
Pernollux Corp. . . . .	78
Poly Paks . . . . .	98, 99
Raytheon . . . . .	59
RCA Electronic Components and Devices Tubes . . . . .	Fourth Cover
RCA Institutes, Inc. . . . .	18-21
RCA Parts and Accessories . . . . .	92
Round Hill Associates Inc. (A Milo Electronics Subsidiary) . . . . .	77
Rye Industries, Inc. . . . .	83
Sams & Co., Inc. Howard W. . . . .	76
Schober Organ Corp., Inc. . . . .	66
Scott, Inc. H. H. . . . .	79
Secore . . . . .	14-15
Shure Bros. . . . .	17
Solid State Sales . . . . .	96
Sonotone Corp. (Electronic Applications Div.) . . . . .	75
Sony Corp. of America . . . . .	66
Sprague Products Company . . . . .	26
Surplus Center . . . . .	94
TechPress, Inc. . . . .	83
Texas Crystals (Div. of Whitehall Electronics Corp.) . . . . .	93
Triplet Electrical Instrument Company . . . . .	Second Cover
Turner Microphone Company, The . . . . .	12
United Radio Co. . . . .	99
Warren Electronic Components . . . . .	97
Weller Electric Co. . . . .	69
Winegard Co. . . . .	24-25
Xcelite, Inc. . . . .	53
<b>MARKET CENTER . . . . .</b>	<b>96-99</b>
Anti-Tobacco Center of America . . . . .	
Arcturus Electronics Co. . . . .	
Edmund Scientific Corp. . . . .	
Hazleton Scientific Co. . . . .	
Leed's Radio . . . . .	
McGee Radio . . . . .	
Salch & Co., Herbert (Marketing Division of Tompkins Radio Products) . . . . .	
Sydmar Electronics Specialties . . . . .	
TAB . . . . .	
<b>SCHOOL DIRECTORY . . . . .</b>	<b>95</b>
Coyne Electronics Institute . . . . .	
Indiana Home Study Institute, The . . . . .	
Northrop College of Science & Engineering . . . . .	
Tri-State College . . . . .	
Valparaiso Technical Institute . . . . .	

WANTED IRE IREE publications. Pick up service on quantities. EPI, Box 67, Palo Alto, Calif. 94301

## ELECTRONICS

BARGAINS in Canadian Electronic equipment and surplus. Send \$1.00 for glant catalogs. ETCO, Box 741, Dept. R, Montreal, Canada

"DISTANCE CRYSTAL SET CONSTRUCTION" Handbook—50¢. Catalog. LABORATORIES, 12041-B Sheridan, Garden Grove, Calif. 92640

TRANSISTOR PROJECTS, kits, catalog 10¢. WORKSHOP, Box 393, Bethpage, N. Y. 11714

JAPAN DIRECTORY. Electronics, general products. Location services. Single replacement parts. Trade paper subscriptions. \$1.00 today. NIPPON SHOGYO, Box 6266, Spokane, Wash. 99207

TUBES. "Oldies", latest. Lists free. STEINMETZ, 7519 Maplewood, Hammond, Indiana 46324

RECEIVING & INDUSTRIAL TUBES, TRANSISTORS, All Brands—Biggest Discounts. Technicians, Hobbyists, Experimenters—Request FREE Giant Catalog and SAVE! ZALYTRON, 469 Jericho Turnpike, Mineola, N.Y. 11501

Discharge IGNITION, PHOTOFASH. Free catalog parts, kits. TRANSPARK, Carlisle, Mass. 01741

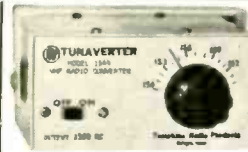

### TUNAVERTERS

POLICE, FIRE, AIRCRAFT, MARINE AND AMATEUR CALLS ON YOUR BROADCAST RADIO! Tunable RF converters. 6-1 reduction tuning.

See complete listing in Sept. RE, page 84. HERBERT SALCH & CO., WOODSBORO RE10, TEX. 78393



CUT DOWN ON MOBIL IGNITION NOISE. DON'T BE FOOLED BY IMITATIONS!

Get the ORIGINAL

SYDOR SOLID STATE "CD" IGNITION SYSTEM! High Quality Components used throughout. Fiberglass Printed Circuit Board. Utilized Construction. Simplified Kit Assembly.

Construction Article in Nov. 1966 Popular Electronics. Thousands of satisfied customers. Write for Free Literature TODAY. COMPAC Assembled \$34.75. COMPAC KIT \$24.95. \*Add 75¢ for mailing and handling N.Y. State Residents add Sales Tax.

SYDOR ELECTRONICS SPECIALTIES 1268 E. 12th St. Brooklyn, N.Y. 11230

## SILICON RECTIFIER SALE

IMMEDIATE DELIVERY FULLY GTD AMERICAN MADE NEWEST TYPE FULLY TESTED

### 1 AMP SILICON "TOPHAT" & EPOXY DIODES

LOW LEAKAGE FULL LEAD LENGTH			
PIV/RMS	PIV/RMS	PIV/RMS	PIV/RMS
50/35	100/70	200/140	300/210
.05 ea.	.07 ea.	.10 ea.	.12 ea.
400/280	500/350	600/420	700/490
.14 ea.	.19 ea.	.21 ea.	.25 ea.
PIV/RMS	PIV/RMS	PIV/RMS	PIV/RMS
800/560	1000/700	1000/700	1100/770
.30 ea.	.40 ea.	.50 ea.	.70 ea.

### ALL TESTS AC & DC & FWD & LOAD SILICON POWER DIODE STUDS

D.C. AMPS	50 PIV 35 RMS	100 PIV 70 RMS	150 PIV 105 RMS	200 PIV 140 RMS
3	.08 ea.	.12 ea.	.16 ea.	.22 ea.
12	.25	.30	.40	.55
35	.65	.90	1.25	1.40
100	1.00	1.50	2.00	2.75
100	2.50	3.00	4.00	5.00

D.C. AMPS	300 PIV 210 RMS	400 PIV 280 RMS	500 PIV 350 RMS	600 PIV 420 RMS
3	.27 ea.	.29 ea.	.37 ea.	.45 ea.
12	.90	1.30	1.40	1.65
35	.90	1.30	2.60	3.00
100	2.50	3.50	4.00	4.75
100	4.25	4.75	5.10	5.00

"SCR" SILICON CONTROLLED RECTIFIERS "SCR" PRV AMP AMP AMP AMP PRV AMP AMP AMP AMP

SPECIALS! SPECIALS! Westinghouse 160 AMP, 500 PIV SILICON HI-POWER STUD RECTIFIER IN1666. Limited quantity. \$5.10 ea. 10 for \$45.00

100 Different Precision Resistors 1/2—1—2 Watt 1/2%—1% TOL \$1.25

Asst transistor Kit. P.N.P.—N.P.N. All popular types. Unchecked. 100 for \$2.95 500 for \$9.95

Computer Grade Condenser 15,500 MFD 12 VDC American Mfg. .75 ea.

Type IN34 DIODE GLASS .07 ea. 100 for \$5

Money Back guarantee. \$2.00 min. order. Include additional \$ for postage. Send check or money order. C.O.D. orders 25% down.

Warren Electronic Components 230 Mercer St., N. Y., N. Y. 10012 • 212 OR 3-2620

Circle 143 on reader's service card

"TAB" • SILICON ONE-AMP DIODES Full Leads Factory Tested & Gtd! U.S.A. Mfg Piv/Rms 50/35 .05 400/280 .14 1000/700 .50 Piv/Rms 100/70 .07 600/420 .21 1700/1000 1.20 Piv/Rms 200/140 .12 800/560 .30 2400/1680 .40 Piv/Rms 300/210 .12 900/630 .40 2400/1680 .70

TERMS: Money Back Guarantee Our 22nd Year. \$2 Min. Add Shipping Charges. 111 GD LIBERTY ST., N. Y., N. Y. 10006 Send 25¢ Phone: REctor 2-6245 for Catalog

NEW SOLID STATE ELECTRONIC KITS No. 140 6 Watt Amplifier. Excellent General Purpose Unit \$8.95 No. 200 Tone Control Amplifier. Adds Tone Controls To Any Amplifier \$4.95 No. 210 High Gain Preamp. 10 & 111 Impedance Inputs Provided \$4.49 No. 370 Variable D.C. Power Supply. 0 To 12V Output At Up To 500MA \$7.49 At your dealer or order direct from: HAZLETON SCIENTIFIC CO. Box 163, Hazel Park, Mich. 48030

WRITE NOW FOR 1968 SENT FREE MCGEE'S CATALOG 1001 BARGAINS IN SPEAKERS—PARTS—TUBES—HIGH FIDELITY COMPONENTS—RECORD CHANGERS—Tape Recorders—Kits—Everything in Electronics 1901 McGee Street, Kansas City (RE), Missouri 64108

**8 PIECE TOOL KIT** 69¢  
10 Shipping contains 4 Bristle Wrenches 1 Hex Blade 2 Alignment (tuning) Tools

**INTERFERENCE TV TRAPPER** SUPPRESS PICTURE INTERFERENCE CAUSED BY:  
• AUTO IGNITION  
• AIRPLANES  
• APPLIANCES  
• NEON SIGNS  
• OIL BURNERS  
• AMATEUR RADIO TRANSMITTERS  
\$1.59 10¢ shipping

**TV LIFESAVER! STOP TUBE BURNOUTS!** PROTECTS IN TIMES FROM BURNOUTS. SAVES YOU MONEY ON SERVICE CALLS! ALSO USE WITH PHONOGRAMS, TAPE RECORDERS, AND ALL TYPES OF INTERRUPTERS. ELECTRONIC TUBES AND BURNERS!  
\$1.79 20¢ shipping

**SILICON RECTIFIERS** all purpose ELECTRONIC CLEANER 89¢

**CORNELL TUBES** 1 YR. GUARANTEED

Mutual Conductance Lab-tested, Individually Boxed, Branded and Code Dated. Tubes are new, or used and so marked.

**33¢ PER TUBE**

100 TUBES OR MORE: **30¢ PER TUBE**

**TUBE CARTONS** HIGH GLOSS CLAY COATED. 11.00 TUBE SUBSTITUTES 1.25

**RADIO-TV TUBE TESTER** 2.89 plus 30¢ shipping

**Special!** With every \$10 Order **25¢** per Tube

(No Limit from this list)  
6AS5 6SN7  
6AQ5 6CB6 6S4  
6AU6 6J6 6W4

**COLOR TV DEGAUSSER** 3.95

**BARGAIN CORNER**  
Solder Iron 1.49  
Elect Tape .89  
Epoxy (pr.) .79  
Diode Kit .39  
Noise Filter .89  
Neon Tester .59  
Solder .39  
Antenna Coupler 1.89  
Battery Charger 4.95

*Prestige & Success are yours as an ELECTRONIC EXPERT*

FOR CORNELL CUSTOMERS ONLY by special arrangement with the publisher, these amazing bargains are available.

COMPLETE RADIO SERVICING AND BASIC ELECTRONICS COURSE ONLY \$3.00 (52 pp. - 100 illustrations)

NEW PRACTICAL TV TRAINING COURSE ONLY \$3.50 (52 pp. - 100 illustrations)

Both above courses \$6.00

**Other tubes at low prices—send for free list**  
NO SUBSTITUTIONS WITHOUT YOUR PERMISSION

**TERMS:** Add 3¢ per tube shipping. Orders under \$5.00 add 3¢ per tube shipping plus 50¢ handling. Canadian orders add approximate postage. Send 25¢ deposit on C.O.D. orders. No C.O.D. orders under \$5.00 or to Canada. No 24 hr. free offer on personal check orders. 3-DAY MONEY BACK OFFER.

# MOVIN' Special!

MADE IN U.S.A. • DC MICRO AMMETERS

2 1/2" 0-100 movement  
\$2.88  
IDEAL FOR \$ METER.



## WORLD'S MOST POPULAR \$1 PARTS PAKS

- 10 TRANSISTOR ELECTROLYTICS: 10mf to 500mf \$1
- 40 "TINY" RESISTORS, 1/10W, 5% tol \$1
- 10 TRANSISTOR SOCKETS for pnp-npn transistors \$1
- 30 MOLDED COND'S. mylar, pore, black beauty \$1
- 10 TRANSISTOR ELECTROLYTICS: 10mf to 500mf \$1
- 50 COILS & CHOKES, if, rf, ant, usc, & more \$1
- 35 TON WATERS, asst incl: A.B., 5% tol \$1
- 30 "YELLOW" MYLAR CONDENSERS, asst val \$1
- 60 CERAMIC CONDENSERS, discs, npo's, to .05 \$1
- 60 TUBULAR CONDENSERS, to .5 mf, to 1 Kv, asst \$1
- 40 DISC CONDENSERS, 27mf to .05mf to 1Kv \$1
- 60 TUBE SOCKETS, receptacles, plugs, audio, etc. \$1
- 30 POWER RESISTORS, 5 to 50W, to 24K ohms \$1
- 65 HALF WATERS, asst incl: A.B., 5% tol \$1
- 60 HI-O RESISTRS, 1/2, 1, 2W, 1% & 5% values \$1
- 10 VOLUME CONTROLS, to 1 meg, switch too! \$1
- 10 ELECTROLYTICS, to 500mf, asst FP & tubulars \$1
- 50 RADIO & TV KNOBS, asst. colors & styles \$1
- 4 TRANSISTOR TRANSFORMERS, asst. worth \$25 \$1
- 40 PRECISION RESISTORS, 1/2, 1, 2W, 1% values \$1
- 40 CORNING "LOW NOISE" resistors, asst. \$1
- 10 PHONO PLUG & JACK SETS, tuners, amps \$1
- 50 TERMINAL STRIPS, 1 to 8 solder lug types \$1
- \$25 SURPRISE PAK: transistors, rect. diodes, etc. \$1
- 10 TUBULAR ELECTROLYTICS, to 500 mf \$1

## SILICON POWER STUD RECTIFIERS

AMPS	Factor <sup>11</sup> Tested	50 PIV	100 PIV	200 PIV
3	74	11e	17e	
15	22e	40e	65e	
45	75e	90e	1.25	
160	2.50	2.95	4.05	
250	4.50	5.50	6.89	

AMPS	400 PIV	600 PIV	800 PIV	1000 PIV
3	22e	31e	40e	59e
15	90e	1.35	1.59	1.79
45	1.59	1.90	2.50	2.95
160	5.75	7.50	9.25	10.95
250	9.59	12.53	15.00	19.95

## FACTORY TESTED \$1 SEMI-KON-DUCTORS

- 2-85 WATT 2N424 PLANAR, silicon, TO-18 npn \$1
- DUAL TRANSISTORS [ PNP (2N2807) ] [ 2N2000 ] \$1
- 4 2N213 TRANSISTORS, silicon, TO18, TO22 \$1
- 3-40W NPN SILICON MESA 2N1618, transistor \$1
- 4 2N170 TRANSISTORS, by GE, npn for gen'l rf \$1
- 10 3 Amp RECT's, stud, silicon, to 800 V no test \$1
- 4-2N255 POWER TRANSISTOR EQUALS \$1
- 10 PNP SWITCHING TRANS'TRS, 2N-404, no test \$1
- 2-800 MC, 2N709 NPN Silicon planar TO46 \$1
- 5 2N107 TRANS'TRS, by GE, pnp, pop, audio pak \$1
- 3-2N1613 3W NPN SIL, 120 mc, by "Rheem" \$1
- 3-45 AMP POWER RECTIFIERS, stud, silicon \$1

Delco  
LIKE DS501  
10 for 75¢ EA  
TRANSISTORS  
PNP 100Watt/15 Amp HI Power  
TO36 Case! up to 50 Volts

TRANSISTORS  
100 for 188  
Supplied with  
SILICON PLANAR  
POWER, RF, IF,  
AUDIO, SWITCHING  
no test

- 5 2N706 500MW, 300MC NPN trans, TO18 \$1
- 10 PNP SWITCHING TRANSISTORS, no test, TO5 \$1
- 4 2N43 OUTPUT TRANSISTORS, by GE, pnp, TO5 \$1
- 4 35-W TRANS'TRS, 2N1434, CBS, TO10, stud. \$1
- 25 GERMANIUM & SILICON DIODES, no test \$1
- 25 TOP HAT RECTIFIERS, silicon, 750 ma, no test \$1
- 2-1000 MC-TRANSISTOR 2N918 NPN SILICON \$1
- 4 2N333 NPN SILICON transistors, Transistor \$1
- 4 BIDIRECTIONAL TRANSISTORS, 2N1611 \$1
- 10 NPN SWITCHING TRANS'TRS, 2N338 no test \$1
- 15 PNP TRANS'TRS, CK722, 2N35, 107, no test \$1
- 15 NPN TRANSISTORS, 2N35, 170, 410, no test \$1

## 1 AMP 800 PIV SUBMINIATURE RECTIFIERS

**POLY PAKS**  
TERMS: send check, money order, include postage—AvC, wt. per pak 1 lb. Rated net 30 days. CODS 25%.  
P.O. BOX 942R  
SO. LYNNFIELD, MASS.  
"PAK-KING" of the World

# MARKET CENTER

**ELECTRONIC PARTS!** Components, transistors, diodes, kits, relays, and many special items. Guaranteed. Send 25¢ for 100 page catalog. GENERAL SALES CO., P.O. Box 2031C, Freeport, Texas 77541

**RADIO & TV TUBES 33¢ each.** One year guaranteed. Plus many unusual electronic bargains. Free catalog. CORNELL, 4217-E University, San Diego, California 92105

**MESHNA'S TRANSISTORIZED CONVERTER KIT** Converts car radio to receive police & fire. 35-50Mc or 100-200Mc. (one Mc tuning) with simple step instructions \$5.00. MESHNA, No. Reading, Mass. 01864

**TV CAMERAS:** Assembled and kits. Also plans, vidicons, lenses, scan coils, etc. NEW catalog 10¢. ATV RESEARCH, Box 453, Dakota City, Nebr. 68731

**GIANT JAPANESE ELECTRONICS CATALOG.** \$1. DEE, 10639A Riverside, North Hollywood, Calif. 91602

## AUDIO - HI-FI

**RENT STEREO TAPES—over 2,500 different—all major labels—free brochure.** STEREO-PARTI, 1616-R Terrace Way, Santa Rosa, Calif. 95404

## UNUSUAL BARGAINS ... MANY U.S. GOV'T SURPLUS

### GIANT WEATHER BALLOONS



"Balls of fun" for kids, traffic stoppers for stores, terrific for amateur meteorologists. Create a neighborhood sensation. Great backyard fun. Exciting beach attraction. Made of heavy duty neoprene. Inflate with vacuum cleaner or auto air hose; or locally available helium for high rise.

Stock No. 60,568EH... (8' diam.) \$2.00 Ppd.  
Stock No. 60,632EH... (16' diam.) \$7.00 Ppd.

### EXPERIMENTAL FUN WITH TESLA COIL

Now perform spectacular experiments without wires... as Nikola Tesla did 50 yrs. ago. Generator with coil, etc., transmits extremely high frequency electromagnetic radiation (millions of cycles per second) through space. Lights fluorescent tube 2 ft. away, ionizes gases, performs total of 21 fascinating experiments. Incl. Neon Lamp, discharge electrode, 2 radiation antenna plates. Generates 5,000 V. for 110 V. 60-C. AC. Meas. 6" x 6"  
Stock No. 70,301EH \$44.00 Ppd.

### ELECTROSTATIC GENERATOR



Volt potential—210,000, yet completely safe for classroom experiments. Demstrate lightning and how lightning rods work! St. Elmo's fire, repulsion of like charges, electrostatic dust collection; the classic "hair-raising effect"; many other electric phenomena. Motor, 110 V, 60-cycle, AC. Humidity range, 0-90%. Current, 1.5 to 2.5 microamps. Aluminum base. Frame and charge collector. Insulating column—unbreakable vinyl chloride plastic. Ht. 17". Dia. 6 1/2". Full instructions on experiments and care.  
Stock No. 70,264EH \$43.50 Ppd.

Order by Stock No. Check or M.O.—Money-Back Guarantee. EDMUND SCIENTIFIC CO., Barrington, N. J. 08007

## CLIP AND MAIL COUPON TODAY

**SEND FOR FREE CATALOG "EH"**  
Completely new 1988 edition. New items, categories, illustrations. Dozens of electrical and electromagnetic parts, accessories. Enormous selection of Astronomical Telescopes, Microscopes, Binoculars, Magnifiers, Magnets, Lenses, Prisms. Many war surplus items for hobbyists, expert mentors, workshop, factory. Mail coupon for catalog "EH".

NAME \_\_\_\_\_  
ADDRESS \_\_\_\_\_  
CITY \_\_\_\_\_ STATE \_\_\_\_\_ ZIP \_\_\_\_\_

WRITE for highest discounts on components, recorders, tapes, from franchised distributors. Send for FREE monthly specials. CARSTON, 1686-R Second Ave. N.Y.C. 10028

**HI-FI COMPONENTS,** Tape Recorders, at guaranteed "WE will not be undersold" prices. 15 day moneyback guarantee. Two-year warranty. NO Catalog. Quotations Free. HI-FIDELITY CENTER, 239R East 149th St., N.Y., N.Y. 10451

**TAPE RECORDER SALE.** Brand new, latest models. \$10.00 above cost. ARKAY SALES, 1028-E Commonwealth Ave., Boston, Mass. 02215

**STEREO TAPES.** Save up to 60% (no membership fees, postpaid anywhere USA). Free 60-page catalog. We discount batteries, recorders, tape accessories. Beware of slogans "not undersold," as the discount information you supply our competitor is usually reported to the factory. SAXITONE, 1776 Columbia Road, Washington, D. C. 20009

**TAPEMATES** makes available to you ALL 4-TRACK STEREO TAPES—ALL LABELS—postpaid to your door—at tremendous savings. For free brochure write **TAPEMATES CLUB**, 5727 W. Jefferson Blvd., Los Angeles, Calif. 90016

**HI-FIDELITY COMPONENTS,** Ham Marine and Communication equipment at considerable savings. If you want to save money write us for our low prices on all your needs. AIREX RADIO CORP., 132 (RE) Nassau St., New York, N.Y. 10038

**NEW HAMMOND REVERBERATION Mechanisms** —\$4. CAL'S, Box 234, Dearborn, Michigan 48121

How to improve your stereo. **ROOM ACOUSTICS** clearly explained. Illustrated handbook \$1.00. ASTROSOUND, Dept. 409, Box 2086, Anaheim, Calif. 92804

**LIKE MUSIC WITHOUT COMMERCIALS?** Completely wired 67 KHz SCA (background music) adapter Model SCA-2 for \$34.95. Five tuned circuits, two silicon transistor amplifier and ratio detector. Four connections to your FM receiver. Instructions included—NO adjustments. Operates on 6 to 12 Volts DC. Size: 2 1/2 x 3 x 3/4 inches. Dealer inquiries invited. Available installed in a nationally advertised six tube AM-FM radio for \$59.95. Also available installed in a nationally advertised ten transistor AM-FM portable for \$79.95. Texas residents add 2% sales tax. KENZAC CO., P.O. Box 66251, Houston, Texas 77006

## INVENTIONS & PATENTS

**INVENTIONS-IDEAS** developed: Cash/Royalty sales. Member: UNITED STATES CHAMBER COMMERCE, Raymond Lee, 130-U W 42nd, New York City 10036

## BUSINESS AIDS

**JUST STARTING IN TV SERVICE?** Write for FREE 32 PAGE CATALOG of Service Order books, invoices, job tickets, phone message books, statements and file systems. OELRICH PUBLICATIONS, 6556 W. Higgins, Chicago, Ill. 60656.

**1,000 Business Cards, "Raised Letters"** \$3.95 postpaid. Samples. ROUTH, 5717 Friendswood, Greensboro, N. C. 27409

**DIAGRAMS,** service information, Radio \$1.00, Television \$1.50. SUPREME, 1760 Balsam, Highland Park, Ill. 60035

Circle 145 on reader's service card



**CLASSIFIED COMMERCIAL RATE** (for firms or individuals offering commercial products or services): 60¢ per word . . . minimum 10 words.

**NON-COMMERCIAL RATE** (for individuals who want to buy or sell personal items): 30¢ per word . . . no minimum.

Payment must accompany all ads except those placed by accredited advertising agencies. 10% discount on 12 consecutive insertions, if paid in advance. Misleading or objectionable ads not accepted. Copy for November issue must reach us before September 8th.

**TWO-WAY RADIO SERVICE INVOICE FORMS**—Detailed. Free Sample Form No. 50 and Catalog. **OELRICH PUBLICATIONS**, 6554 W. Higgins, Chicago, Ill. 60656

Attention: TV Service Dealers. **HIGHLY DETAILED TV SERVICE ORDER FORM STOPS PRICE COMPLAINTS BEFORE THEY START. FREE CATALOG AND SAMPLE NO. 206. OELRICH PUBLICATIONS**, 6554 W. Higgins, Chicago, Ill. 60656

Attention: TV Service Dealers. **TV SERVICE CONTRACTS FORMS. Free Catalog and Samples No. 105. OELRICH PUBLICATIONS**, 6554 W. Higgins, Chicago, Ill. 60656

**"PROFIT GUARD" BOOKKEEPING SYSTEM FOR TV SERVICE.** Complete—easy to use. Free Catalog and Sample No. 1800 Page. **OELRICH PUBLICATIONS**, 6554 W. Higgins, Chicago, Ill. 60656

**REGISTRY AND JOURNAL for TV APPLIANCE AND EQUIPMENT DEALERS.** Keeps record of daily sales by make, model, serial, etc. Stops inside theft. Provides quick reference. Free catalog and sample page No. 1700. **OELRICH PUBLICATIONS**, 6554 W. Higgins, Chicago, Ill.

## EDUCATION/ INSTRUCTION

**LEARN ELECTRONIC ORGAN SERVICING.** New home study course covering all makes electronic organ including transistors. Experimental kits—schematics—trouble-shooting. Accredited NHSC-GI Approved. Write for free booklet. **NILES BRYANT SCHOOL**, 3631 Stockton Blvd., Dept. F, Sacramento 20, Calif.

**WANTED! TV-RADIOMEN** to learn aircraft electronics servicing. Numerous job openings everywhere. Write: **ACADEMY AVIONICS**, Reno/Stead Airport, Reno, Nevada

**HIGHLY EFFECTIVE HOME STUDY COURSE** in Electronics Engineering Mathematics with circuit applications. Earn your Associate in Science degree. Free literature. **COOK'S INSTITUTE OF ELECTRONICS ENGINEERING**, P.O. Box 36185, Houston, Texas 77036 (Established 1945.)

**HIGHLY EFFECTIVE HOME STUDY REVIEW** for FCC commercial phone exams. Free literature. **COOK'S SCHOOL OF ELECTRONICS**, P.O. Box 36185, Houston, Texas 77036

**ASSOCIATE DEGREE IN ELECTRONICS** earned, first half by correspondence and second half in residence. Free catalog. **GRANTHAM INSTITUTE**, 1505 N. Western Ave., Hollywood, Calif. 90027

## Just Published

### How 88,648 Heavy Smokers Stopped Smoking

**NEW YORK**—The Anti-Tobacco Center of America has just published a booklet which explains how 88,648 heavy smokers (of whom many are physicians) have stopped smoking without straining their will power. This booklet is available free of charge to smokers. All you need to do, to obtain it, is to send your name and address to The Anti-Tobacco Center of America, Dept. 641-M, 366 Fifth Avenue, New York 1, New York. This offer is open while the supply of these booklets lasts.

FCC First Class License in six weeks—nation's highest success rate—approved for Veterans Training. Write **ELKINS INSTITUTE**, 2603E Inwood Road, Dallas, Texas 75235

**"SLEEP-LEARNING."** Send for free brochure, "What's It All About." **TAPES**, Box-190RE, Quincy, Mass. 02169

**WATCH REPAIRING.** Learn to repair American and Swiss watches in spare time at home. Tuition \$5 monthly. Diploma awarded. Free sample lesson. No obligation. **CHICAGO SCHOOL**, Dept. REK, Fox River Grove, Ill. 60021

Top Paying Jobs—Guidance Manual \$1. **CANADIAN INSTITUTE OF SCIENCE & TECHNOLOGY**, 263E Adelaide St. W., Toronto

## SERVICES

**TECH MANUALS**, bought and sold on military surplus and civilian electronic equipment. **SLEEP ELECTRONICS COMPANY**, Drawer 178RE, Ellenton, Fla. 33532

## GOVERNMENT SURPLUS

72 page illustrated Government Surplus Radio, Gadgets Catalog 25¢. **MESHNA**, Nahant, Mass. 01908

## \$1.00 SALE \$1.00 SALE

THE PACKS LISTED BELOW  
ARE YOURS FOR \$1 EACH

### Compare Our Prices

- 4—50' SPOOLS HOOKUP WIRE
- 24—PILOT LIGHTS/110—ASST. MICA CONDENSERS
- 85—ASST. DISC. CERAMIC COND.
- 12—ASST. RADIO ELECTROLYTIC CONDENSERS
- 60—ASST. TUB. CONDENSERS .001 to .47 to 600 v.
- 6—ASST. SELENIUM RECTIFIERS 65, 100, 300 ma. etc.
- 8—ASST. TV ELECTROLYTIC CONDENSERS
- 6—ASST. TRANSFORMERS/6—AUDIO OUTPUT. TRANSF.
- 15—ASST. DIODE CRYSTALS/12—STANO. TRANSISTORS
- 6—TOP HAT SILICON RECT./4—ELEC. COND. 50-30-150V
- 6—I.F. COIL TRANSFORMERS sub. mln. for Transist.
- 75—ASST. 1 W. RESISTORS Stand. choice values
- 40—ASST. 2 W. RESISTORS Stand. choice values
- 60—PRECISION RESISTORS ASST.
- 24—ASST. WIREWOUND RESISTORS 5, 10, 25 watt
- 6—PNP TRANSISTORS General purp. TO-5 case
- 6—NPN TRANSISTORS General purp. TO-5 case
- 17 ASST. ROTARY SWITCHES All pop. types
- 15—ASST. VOL. CONTROLS/100 IRC/AB ASST. RES.
- 25—ASST. BATHTUB CAPACITORS. 1-MFD—2-MFD
- 10—TOGGLE SWITCHES-SPST Removed from new equip.
- 8—TOGGLE SWITCHES-DPDT Removed from new equip.
- 10—TOGGLE SWITCHES-SPDT Removed from new equip.
- 10—TOGGLE SWITCHES-DPST Removed from new equip.
- 3—POWER XFOMERS 115V & H.I.V.—SEC.
- 100 FT.—300 OHM TV LEAD-IN WIRE
- 4—PL259 OR 4—SO239 RF CONNECTORS
- 6—ASST. DC. RELAYS/24 ASST.-IN34-DIODES
- 8—1 1/2" BLK. INST. MIL. KNOBS, 6—1 1/4" or 5—2"
- 6—BOGEN-HI-FI-AMP. KNOBS-PUSH-ON-NUMBERED -0-10

No C.O.D. Orders—\$5.00 Min. Please Include Postage

**WRITE FOR OUR PARTS & TUBE CATALOG, LOWEST WORLD PRICE ON BRAND NEW TUBES, ESTABLISHED 1926**

**LARGEST STOCK OF XMITTING & SPECIAL PURPOSE TUBES IN THE U.S.A.**

## UNITED RADIO CO.

56 FERRY ST., NEWARK, N.J. 07105

Circle 146 on reader's service card

**FAIRCHILD** 200 mc **PLASTIC** **Transistors** **CHOOSE ANY**

BVCBO hFE **3** for **\$1**

50-200 400 **600 MC** **2N3563**

**FREE** **OUR STOP** **WITH \$5** **EVERY** **ORDER** **FREE** **BARGAIN** **CATALOG**

**GUARANTEES AS ADVERTISED for 6 months**

## FIELD EFFECT TRANSISTORS

**2N3088** **129** **2\$1** **For 1**

N-channel  amplifier infrared,  N-channel

**DRAIN** "MOST." **2N4353** **p-channel**

**GATE 1** **GATE 2** **IGFET** **Input** **225**

**SOURCE** 10 million meg-

**LOOK** **FIELD-EFFECT** **TRANSISTORS** **PHOTOCONDUCTIVE CELL**

**144** **EACH**

**LOOK IN A LIFETIME BUY!**

**HERMETICALLY SEALED**

**1 AMP** **SILICON RECTIFIERS**

TESTED	PIV	Sale	PIV	Sale	PIV	Sale
50	5¢	800	23¢	1800	99¢	
100	7¢	1000	40¢	2000	1.50	
200	9¢	1200	59¢	3000	1.90	
400	11¢	1400	69¢	4000	2.50	
600	19¢	1600	89¢			

**ZENER** **RECTIFIERS** **1 AMP** **Actual Size**

1 WATT . . . . . 49¢  MICROMINIATURE

10 WATTS . . . . . 1.00 **600 PIV** **6 for \$1.00**

**2 AMP** **1000 PIVs**  SET OF 3

**1 AMP** **MINIATURE** **SILICON** **RECTIFIERS**

PIV	Sale	PIV	Sale
400	17¢	800	27¢
600	22¢	1000	39¢
100	9¢		
200	12¢		

Glass! Epoxies!

**"ONE PRICE"** **2 AMP** **SILICON** **RECTIFIERS**

**FACTORY TESTED SCRS!** **check amp and PRV blocks.**

7-amp  16-amp  25-a

PRV	Sale	PRV	Sale
50	55¢	600	3.35
100	75¢	800	4.50
200	1.35	1000	5.59
400	2.25		

**POLY** **PAKS** **TERMS: send check, money order, include postage—avg. wt. per pak 1 lb. Retail, net 30 days. Coll. 25%**

**P.O. BOX 942R** **SO. LYNNFIELD, MASS.** **"PAK-KING" OF THE WORLD**

Circle 144 on reader's service card

# NOW

## A low cost Crystal for the Experimenter

### International



### type "EX"

# \$3.75

Postage Paid

- LOW COST
- MINIMUM DELIVERY TIME

3,000 KHz to 60,000 KHz

**SPECIFICATIONS:** International Type "EX" Crystal is available from 3,000 KHz to 60,000 KHz. The "EX" Crystal is supplied only in the HC-6/U holder. Calibration is  $\pm .02\%$  when operated in International OX circuit or equivalent.

**CONDITIONS OF SALE:** All "EX" Crystals are sold on a cash basis, \$3.75 each. Shipping and postage (inside U.S. and Canada only) will be prepaid by International. Crystals are guaranteed to operate only in the OX circuit or its equivalent.

**MINIMUM DELIVERY TIME** We guarantee fast processing of your order. Use special EX order card to speed delivery. You may order direct from ad. We will send you a supply of cards for future orders.

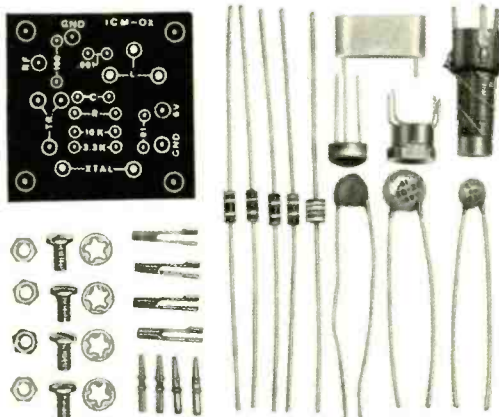
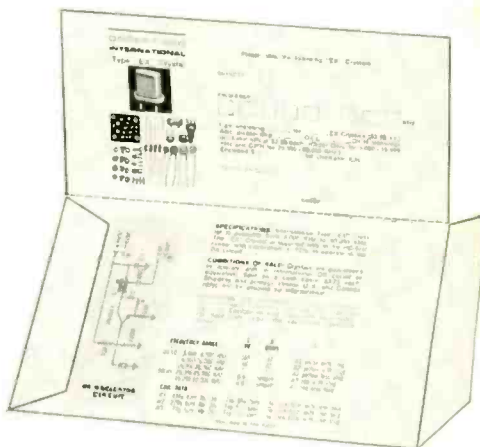

#### COMPLETE OX OSCILLATOR KITS

Everything you need to build your own oscillator. Two kits available. "OX-L" kit 3,000 to 19,999 KHz. "OX-H" kit 20,000 to 60,000 KHz. Specify "OX-L" or "OX-H" when ordering.

# \$2.35

Postage Paid

#### ORDERING INSTRUCTIONS

- (1) Use one order card for each frequency. Fill out both sides of card.
- (2) Enclose money order with order.
- (3) Sold only under the conditions specified herein.



**CRYSTAL MFG. CO., INC.**  
10 No. Lee • Okla. City, Okla. 73102

Circle 148 on reader's service card

# cortina®

The most exciting innovation in solid state stereo history.

Engineering excellence, 100% capability, striking esthetics — all at budget prices. We call it the industry's only **TOTAL PERFORMANCE STEREO** at lowest cost.

■ A full capability 70-watt All Silicon Solid State Stereo Amplifier for \$89.95 kit, \$129.95 wired, including cabinet. Cortina 3070.

■ An Automatic FM Stereo Tuner for \$89.95 kit, \$129.95 wired, including cabinet. Cortina 3200.

■ A 70-Watt Solid State FM Stereo Receiver for \$159.95 kit, \$239.95 wired, including cabinet. Cortina 3570.

The most electronics value for your money has been the EICO design philosophy for 22 years. Its successful expression in stereo is the new Cortina Series. In performance, specifications, circuitry, controls, decor — in everything you expect of professional quality stereo, you'll see that

nothing has been sacrificed — except high price. Let yourself in for one of the pleasant surprises in stereo history: hear Cortina, see it, examine it at your local EICO dealer. Compare and judge critically for value. We believe you'll conclude with Popular Science "The EICO Cortina Series are low-cost audio components that look, and sound, like high-cost components."

**SIMPLIFIED KIT ASSEMBLY** — New EICO exclusive circuitry techniques make kit building easier, faster and more enjoyable. RF, IF and Multiplex circuitry of the tuner and receiver are all supplied completely pre-assembled and pre-aligned. Each channel of the amplifier and receiver uses 3 etched printed-circuit module boards.

**NEW ULTRA-COMPACT BOOKSHELF SIZE COMPONENTS**

"The... compact dimensions and attractive styling appealed

to us. The Cortina 3070 represents a wholesome trend away from "overblown" amplifiers which are much larger than need be. In fact, it is one of the very few we have seen which are actually suitable for bookshelf mounting." Hirsch-Houch Labs.

**CORTINA TECHNICAL HIGHLIGHTS:**

**AMPLIFIER** — Total Music Power: 70W into 4 ohms; 50W into 8 ohms. Harmonic Distortion: less than 0.8%. IM Distortion: less than 2% at full power. Hum & Noise: 72db below rated output. Frequency Response:  $\pm 1.5$ db 5Hz to 100kHz;  $\pm 0.5$ db 8Hz to 60kHz. Channel Separation: 40db. Size (HWD) 3 $\frac{1}{2}$ " x 12" x 7 $\frac{3}{4}$ ".

**TUNER** — Usable Sensitivity 1HF: 2.4 microvolts for 30db quieting. Channel Separation: 40db at 1kHz. Signal-to-Noise Ratio: 60 db. Capture Ratio: 4.5db. Image Rejection: 45db. Selectivity: 45 db. Audio Frequency Response:  $\pm 1$ db 20Hz to 15kHz. Size (HWD) 3 $\frac{1}{2}$ " x 12" x 7 $\frac{3}{4}$ ".

**RECEIVER** — Same as above Cortina Tuner and Amplifier. Size (HWD) 4 $\frac{1}{2}$ " x 16" x 9".

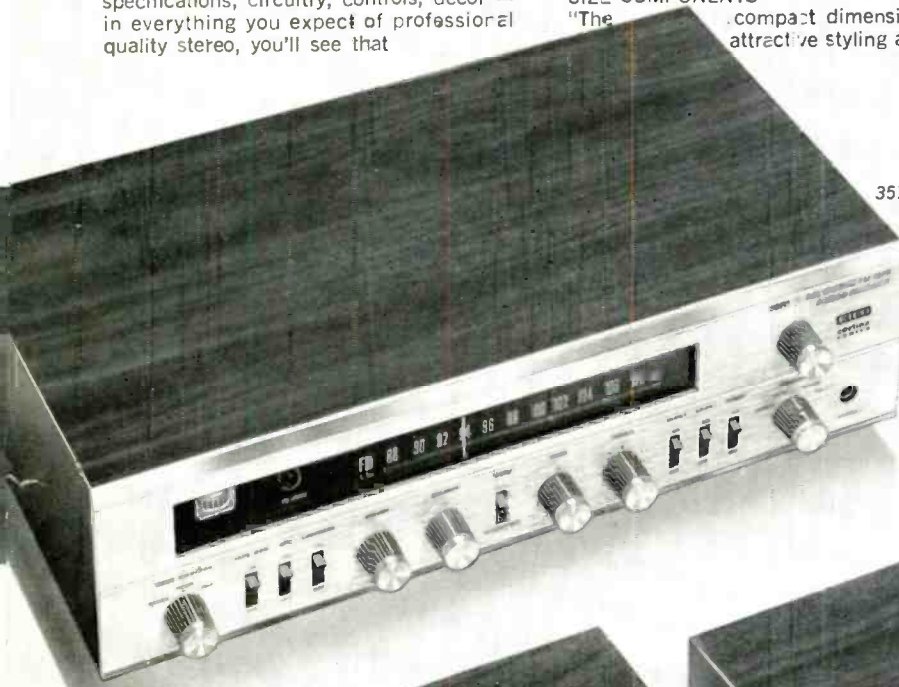

3570 FM Stereo Receiver



3070 70W Stereo Amplifier



3200 FM Stereo Tuner

**EICO Electronic Instrument Co., Inc.**

131-01 39th Avenue, Fushing, N. Y. 11352

- Tell me where I can have a free Cortina demonstration.
- Send me free 36-page catalog on EICO's 200 "best-buy" products.

Name \_\_\_\_\_

Address \_\_\_\_\_

City \_\_\_\_\_

State \_\_\_\_\_ Zip \_\_\_\_\_



**How else but with RCA HI-LITE color picture tubes  
can you bring today's color to your customers?**

Your service reputation is the cornerstone of your business. That's why there's no room to compromise with quality in the components you install.

RCA HI-LITE picture tubes enable you to offer your customers TODAY'S COLOR... incorporating the latest technology of the world's most experienced picture tube manufacturer. They're the same tubes that go into today's original equipment sets.

RCA's new Perma-Chrome process for rectangular picture tubes, for example, means locked-in color purity from the moment the picture comes on. Faster servicing for you. Added customer satisfaction.

Install an RCA HI-LITE and you literally "up-date" your customer's set while, at the same time, enhancing your service reputation.

RCA Electronic Components and Devices, Harrison, N.J.



**The Most Trusted Name in Electronics**